

EasyTREK

SCD—300 compact ultrasonic level transmitter
series for free flowing solids

Installation and programming manual
7th edition



Manufacturer:
NIVELCO Process Control Co.
H-1043 Budapest, Dugonics u. 11.
Tel.: (36-1) 889-0100 Fax: 889-0200
E-mail: sales@nivelco.com www.nivelco.com



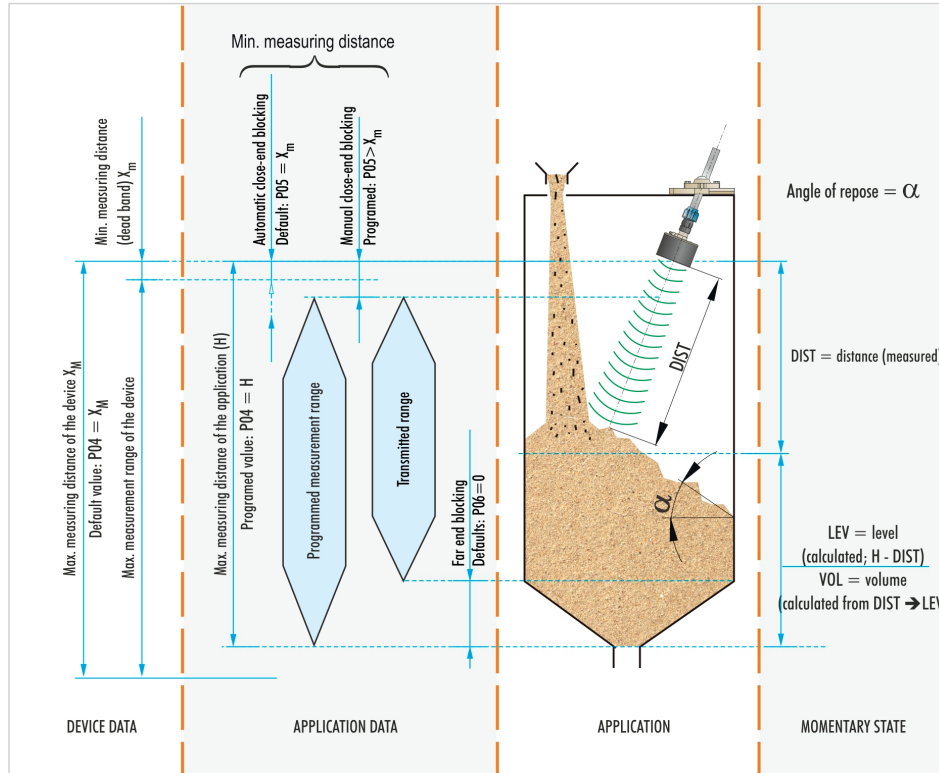

BASIC CONCEPTS AND ELEMENTS



CONTENTS

1. INTRODUCTION	5
2. TECHNICAL DATA.....	6
2.1. GENERAL DATA.....	6
2.2. SPECIAL DATA	7
2.3. EX INFORMATION.....	7
2.3.1. ATEX certificate No.: BKI16ATEX0020X/1.....	7
2.3.2. EACEx certificate No.: RU C-HU. IM43.B.01471	7
2.4. ACCESSORIES.....	7
2.5. ORDER CODES	8
2.6. DIMENSIONS.....	9
3. INSTALLATION	10
4. WIRING	11
4.1. WIRING CONDITIONS.....	11
4.2. CONNECTION CABLE EXTENSION	11
5. PUTTING INTO OPERATION, ADJUSTING, PROGRAMMING.....	13
5.1. PUTTING INTO OPERATION	13
5.1.1. Status indication signals in measuring mode	14
5.2. SPECIAL CONDITIONS OF EX USE	14
5.3. PROGRAMMING	14
5.4. PARAMETERS –DESCRIPTION AND PROGRAMMING.....	15
5.4.1. Measurement Configuration.....	15
5.4.2. Current value.....	20
5.4.3. Relay output.....	21
5.4.4. Measurement optimization.....	22
5.4.5. Volume measurement.....	26
5.4.6. Linearisation.....	27
5.4.7. Informational parameters.....	28
5.4.8. Test parameters.....	29
5.4.9. Error codes.....	30
6. MAINTENANCE, REPAIR.....	30
7. STORAGE CONDITIONS	30
8. PARAMETER TABLE.....	31



CERTIFICATES:		Reference document number
	BKI ATEX, Certificate No.: BKI16ATEX0020X/1	scd3404m060bp_07
	EAC, Certificate No: RU C-HU. IM43.B.01471	scd3404o0600p_02

Thank you for choosing a NIVELCO instrument.

1. INTRODUCTION

The EasyTREK SCD-300 series compact ultrasonic transmitters from NIVELCO are designed to measure the level of free flowing solids, granules and powders. The unit does not touch the material to be measured and does not include any moving parts. Thus, it is not exposed to mechanical loading, no abrasive effect is expected and regular maintenance is not required.

A beam angle of 5° at -3 dB is a feature of all NIVELCO's ultrasonic sensors designed for the level measurement of free flowing solids.

This uniquely narrow beam angle ensures reliable measurement in narrow silos with uneven side walls or sometimes even in the presence of dusting.

Furthermore, as a result of the narrow beam angle – the emitted ultrasonic signals have an outstanding focusing – a sufficient signal penetration through dust is ensured. Modifying of the factory default settings of the level transmitter is possible **only via HART communication**.

OPERATION PRINCIPLE

The ultrasonic level metering technology is based on the principle of measuring the time required for the ultrasound pulses to make a round trip from the sensor to the level to be measured and back.

The sensor emits an ultrasonic pulse train and receives the echoes reflected. The intelligent electronic device processes the received signals by selecting the echoes reflected from the surface and calculates the distance from the time of flight between the sensor and the surface of the medium. This is the basis for all other output signals (level or volume) of the EasyTREK! For measuring the level of the medium the greatest distance of the application (H) has to be programmed.

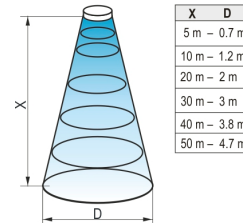

Diameters corresponding to the 5° beam angle.

Minimum measuring distance (X_m): is the construction defined smallest distance within which measurement is not possible (Dead Band; see 5.3. Parameters P05). In special applications this range should be extended with programming (close end blocking)

Maximum measuring distance (X_M): is the construction defined greatest distance, which can be measured by the unit under ideal conditions. No measurement is possible over this distance i.e., maximum distance of the application H must not be greater than X_M . Under unfavorable circumstances such as bad reflection or heavy dusting of the material the measuring capability may be reduced up to the half of the unit's best performance.

The following types of applications are possible depending on the communication and what the output signal is used for:

1. 1.Using the unit as a three - or four -wire current transmitter.

Normally, we use the analogue (4...20 mA) output signal of the EasyTREK. The application parameters of the device are set through HART communication at installation (right after installation or in a laboratory, prior to installation). In this case the short address of the device should stay the factory default: P19 = 0.

2. 2.Using both, current transmission and digital (HART) signal transfer in single transmitter systems.

Digital signal transfer is also used beside the standard utilization of the output current of the EasyTREK. In this case, there can be one or more devices in the current loop that use analogue signals (with their total resistance being $R_t = 250 \dots 600 \Omega$) and one HART master device.

The short address of the EasyTREK should stay the factory default: P19 = 0. This application can be achieved with using a MultiCONT unit as the HART master which ensures the power supply of the EasyTREK too.

3. 3.Simultaneous control of several EasyTREK transmitters with the help of a MultiCONT.

In this case all of the EasyTREK s keep the connection with the MultiCONT through HART communication only.

This means that the measurement values are collected in cycles, and that the modifications of the transmitter settings are arbitrary.

The short addresses of the units are P19 = 1...15. All types of setting and programming tasks can be done through a MultiCONT.

2. TECHICAL DATA

2.1. General data

Type		SCD-3□□-□
Transducer material		Closed cell PVC foam sensor face PP and Aluminum transducer housing and fitting
Beam angle		~ 5°
Process temperature		-30...+60 °C (-22...+140 °F)
Process pressure (absolute)		0.7...1.1 bar (10...16 psi) $P_{absolute}$ and ± 0.1 bar (± 1.45 psig) difference between ambient and tank/silo pressure
Power supply / consumption		11.4...40 V DC / 4.1 W or 11.4...28 V AC (50/60Hz) / 4,6 VA
Accuracy*		$\pm (0.2 \% \text{ of the measured distance} + 0.1\% \text{ of the measurement range})$
Resolution		10 mm (0.4 inch)
Output	Analog	4...20 mA, $R_{tmax} = 600 \Omega$, galvanic isolation, protection against surge transients If no echo: continuous 3.6 mA or 22 mA (selectable with programming)
	Relay	Relay (SPST), 48V AC / 5 A
	Digital communication	HART® standard on the current output
Damping time		3...1000 s (selectable with programming) Default value: 300 s
Electrical connection		7x0.5 mm ² (AWG20) shielded cable $\varnothing 7.5$ mm ($\varnothing 0.3$ inch) standard length: 3 m (16.5 ft) (available to order up to 30 m [100 ft])
Electrical protection		Class III
Ingress protection		IP 65

* Under optimal conditions and constant transducer temperature.

2.2. Special data

Type	SCD-34□-4	SCD-34□-8 Ex	SCD-33□-4	SCD-33□-8 Ex	SCD-31□-4	SCD-31□-8 Ex
Maximum measuring distance X_M		15 m (50 ft)		30 m (100 ft)		60 m (200 ft)
Minimum measuring distance X_m		0.6 m (2 ft)		0.6 m (2 ft)		1 m (3.3 ft)
Ultrasound frequency		40 kHz		30 kHz		15 kHz
Weight		~3.5 kg (7.7 lb)		~3.5 kg (7.7 lb)		~6.5 kg (14.33 lb)

2.3. Ex information

2.3.1. ATEX certificate No.: BK116ATEX0020X/1

Type	SCD-3□□-8 Ex	
Ex marking (ATEX)	II 1 D Ex ma ta IIIC T85°C...T130°C Da	
Transducer material	Closed cell PVC foam sensor face, Aluminum transducer housing and fitting	
Process temperature	-30...+60 °C (-22...+140 °F)	
Max. surface temperature	+130 °C (266 °F)	
Output	Analog	4...20 mA, $R_{max} = 600 \Omega$, galvanic isolation, protection against surge transients If no echo: continuous 3.6 mA or 22 mA (selectable with programming)
	Relay	Electronic switch: SPST 48 V AC 50 V DC / 1 A
	Digital communication	HART® standard on the current output

2.3.2. EACEx certificate No.: RU C-HU. IM43.B.01471

Type	SCD-3□□-8 Ex	
Ex marking (EACEx)	Ex ma ta IIIC T85°C...T130°C Da	
Transducer material	Closed cell PVC foam sensor face, Aluminum transducer housing and fitting	
Process temperature	-30...+60 °C (-22...+140 °F)	
Max. surface temperature	+130 °C (266 °F)	
Output	Analog	4...20 mA, $R_{max} = 600 \Omega$, galvanic isolation, protection against surge transients If no echo: continuous 3.6 mA or 22 mA (selectable with programming)
	Relay	Electronic switch: SPST 48 V AC 50 V DC / 1 A
	Digital communication	HART® standard on the current output

2.4. Accessories

- Installation and Programming Manual,
- Warranty Card,
- EU Declaration of Conformity

ACCESSORIES (SOLD SEPARATELY)

- Split flange (order code: SFA – 3□5)

2.5. Order codes

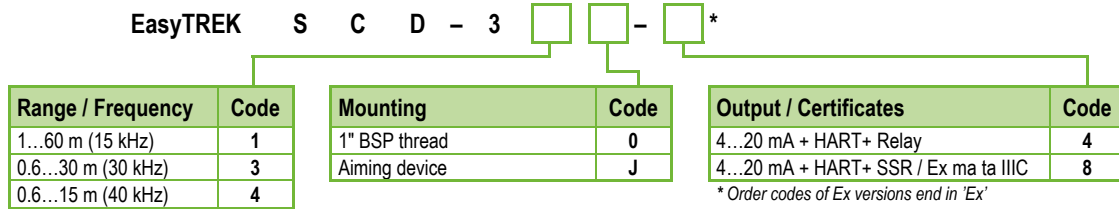

2.6. Dimensions

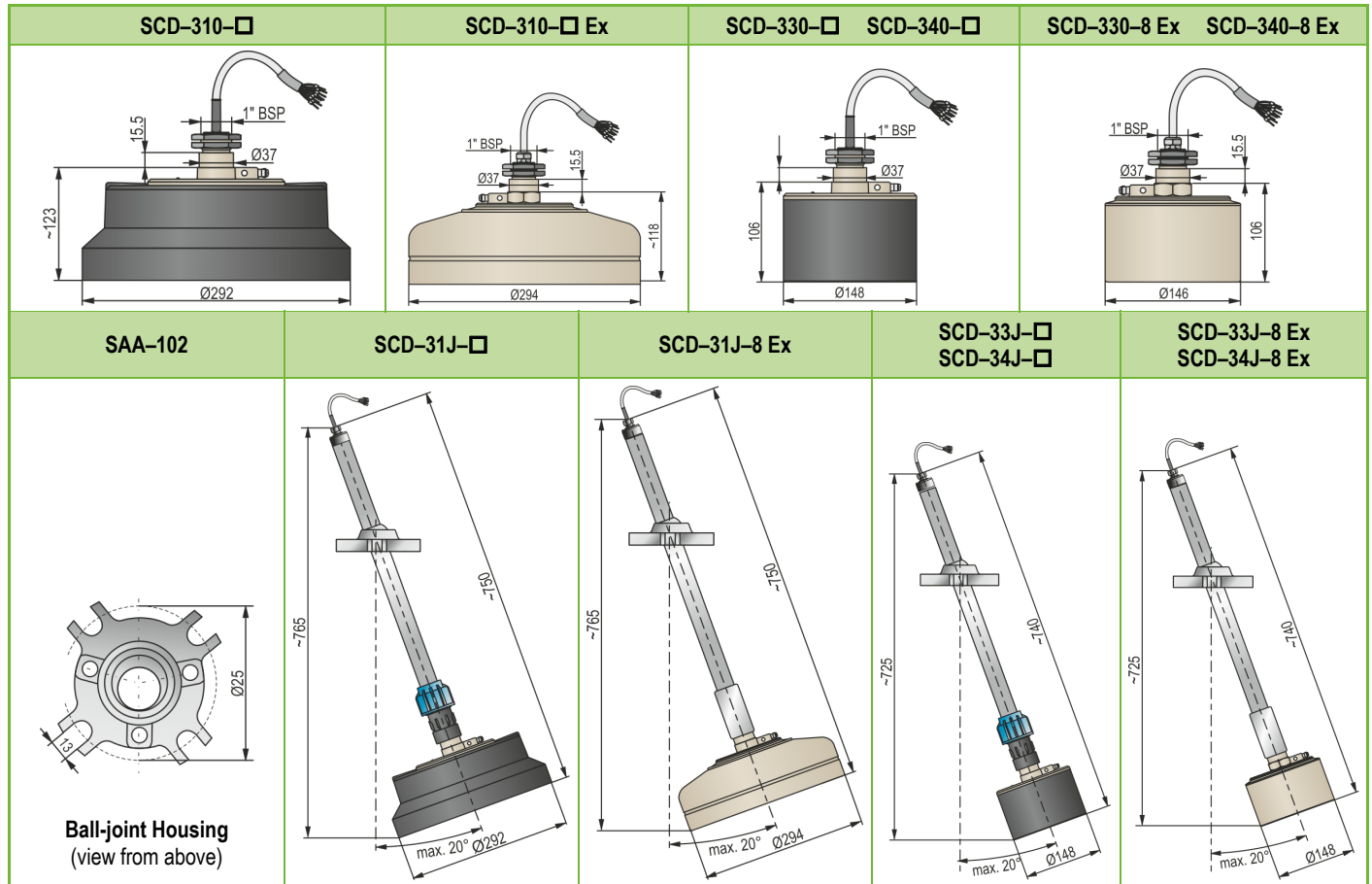

3. INSTALLATION

PLACEMENT

To find the ideal position for the location of the EasyTREK level transmitter various considerations should be made. The transmitter should not be installed in the center of the tank/silo when the tank roof is dome shaped or conical. The ideal position for the EasyTREK is on the $r = (0.3...0.5) R$ (in case of cylindrical tank).

Avoid that the 5° conical beam angle of the transmitter contact the tank/silo wall. This case the transmitter is mounted too close to the wall, therefore it should be tilted (See section "Aiming").

To avoid overheating the instrument should be protected against direct sunshine.

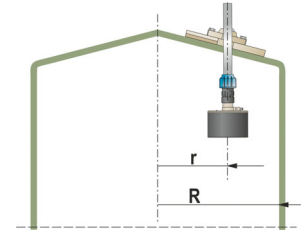

GRAVITY FILLING

Select a location that is as far away from the filling point(s) as possible.

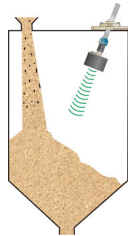

PNEUMATIC FILLING

Select a location where the speed of the in-flowing material is the smallest.

Ex type units are not allowed to be installed in the dust path of the pneumatic filling!

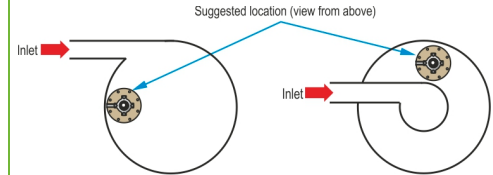

MOUNTING (see illustration of mounting options on the next page)

The EasyTREK consists of a sensor that is attached to the aiming arm (a pipe with a ball-joint housing incorporating a ball joint) that is attached to the integrated level transmitter. It is recommended to mount the transmitter on the roof of the tank/silo using a flange (see drawing above). The Ball-joint housing has a screw-hole diameter of $\text{Ø } 125 \text{ mm}$ (4.9 inches) for fixing it. For easy installation we recommend using our special flange with a split insertion, available in four sizes of DN125/150/200/300 (to be ordered separately). Removing the split insertion, the flange is to be put around the aiming arm and the ball-joint housing is to be fixed to the split flange. It is essential to use the washers and the bolts (4 pcs each) delivered with the split flange. The ball-joint will be pressed to the housing by a spring allowing adjustment/aiming.

The 4 pcs of M12 bolts have to be tightened only after completing the adjustments/aiming (see Figure 1.). The maximum torque for tightening the bolts is 3.5 Nm.

When the entire tilting range of the aiming arm is required, the thickness of the roof cannot exceed the values specified below.

The EasyTREK can also be mounted on existing (manhole) covers, access lids or for instance on a steel structure lowered into a larger (e.g.: $0.5 \times 0.5 \text{ m}$ [$19,7 \times 19,7 \text{ inch}$]) opening on the roof. This solution is to be used with roofs thicker than 350...380 mm (13.8...14.9 inch).

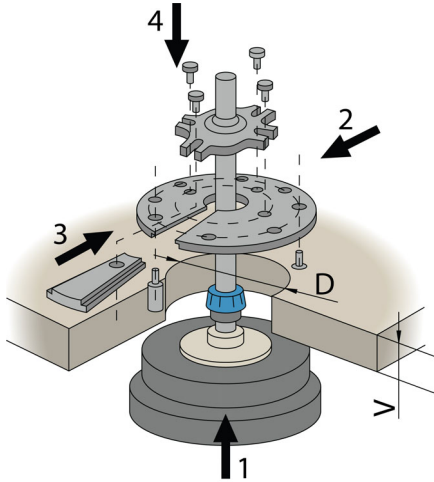

Figure 1. Illustration of mounting

DIAMETER OF THE OPENING D (mm / inch)	MAXIMUM THICKNESS OF THE ROOF V (mm / inch)
160 / 6.3	110 / 4.3
190 / 7.5	150 / 5.9
230 / 9	200 / 7.9
300 / 11.8	280 / 11
340 / 13.4	300 / 11.8

4. WIRING

4.1. Wiring conditions

- The transmitter is SELV supplied. In the case of DC supply the connection is independent of polarity.
- Only SELV circuits can be switched on to the relay or the solid state output.
- The house must be grounded to have noise protection; it should be grounded to the equipotential bonding net.
- 3-wire DC powered devices can be created by connecting one of the power supply wires to the white wire of the current output (GND).
- The units and the cables should be arranged so that the fastening outside the device relieves the end of the cable of any traction.

4.2. Connection cable extension

- The shielding should be connected to the shielding of the extension cable and it should be grounded at the processing unit.

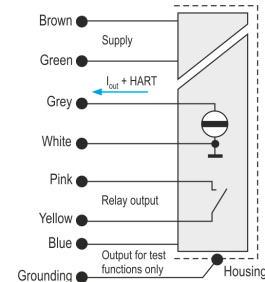

Figure 2.

Color codes of the outputs

5. PUTTING INTO OPERATION, ADJUSTING, PROGRAMMING

5.1. Putting into operation

After switching on the correctly wired unit the transducer begins to click audibly. In about 20...50 s the ECHO LED goes on and a signal between 4...20 mA appears on the current output. When first powering the unit, it measures with the standard manufacturer's settings (see some of the most important parameters below).

DEFAULT PARAMETERS

All the transducers get the same factory default parameters that can also be reset later if needed. Some of the most important parameters of the EasyTREK SCD-300 series can be found below.

- Measurement mode: level (LEV),
- Zero level is assigned to the maximum measuring distance (X_M).
- 4 mA is assigned to the X_M maximum measuring distance (minimum level)
- 20 mA is assigned to the X_m minimum measuring distance (maximum level)
- Current output holds last value in case of error
- Damping: 300 s

All the other measurement values are set to fit the values suitable for standard tasks. The functions used in special cases are switched off.

AIMING THE SENSORS

When the material to be measured is being filled or emptied, because of the formation of an angle of repose, the vertically installed transmitter will experience a weak signal. This can be eliminated in most cases by tilting the unit, so the aiming device is a very important part of these transmitters. The proper aiming can be set and checked while the transmitter is being used, desirably when the silo / tank is almost empty. Usually, it is best that the transmitter points to the middle of the bottom of the silo/tank.

In cases when the silo is narrow, and the height / diameter value equals to or is more than 5, tilting is usually not necessary. Aiming should also be checked when the silo / tank is full, because the echo can be adversely weak even when coming from a nearby surface. This usually happens when the angle of repose is big. In this case an optimal solution must be found in which the echo coming from any distance is acceptable. The SERVICE PARAMETERS that can be reached during programming provide help for set-up. That means that the aiming adjustment and the programming should be done at the same time. The strength of the echoes can be checked in the Echo Map window of the EView software or in the Echo menu of the MultiCONT device.



5.1.1. Status indication signals in measuring mode

HART respond signals

The properly installed device with factory default settings gives the following responses to the COM3 universal HART command:

primary value	Level	
secondary value	Level	
tertiary value	Distance	
quaternary value	Temperature	(See P01 programming).

LED status signals on the unit

Green LED **COM**

Lights up during HART programming.

Red LED **ECHO**

Lights up when the device gets proper echoes.

5.2. Special Conditions of Ex use

- The apparatus nor any part of it is not suitable as a fire resistant barrier for the Zone 20 area. The equipment is not allowed to be installed in the dust path of the pneumatic filling!
- The instrument should be grounded by all its grounding screws to the EP system in order to avoid electrostatic charges.
- For connecting the cable of the level transmitter, a suitable terminal box should be selected in accordance to the electrical classification of the area and the cable outside the unit should be fixed so that it is tension-free.
- As a result of the mounting arrangement of the unit the ambient temperature is equal to the process temperature.
- The current output should be connected to a galvanic isolator.

5.3. Programming

HART interface of the EasyTREK enables full access and programming of the complete parameter set.

Parameters can be accessed by two ways:

- With the aid of EView configuration software run on PC
- By the NIVELCO made MultiCONT multichannel controller

This instruction describes parameters and features behind them but does not deal with technical details for their selection and editing of their values. Compact Disk attached to the transmitter contains detailed information on the Eview configuration software (to install on PC) and its description. Programming by the MultiCONT can be taken from its Installation and Programming Manual.

Continuous measuring is going on during programming in accordance with the last programmed parameter set. This way the analogue output signal (4...20 mA) continuously represents the actual value. The digital (HART) communication depends on the communication software. The new, modified parameter set will be valid after returning to measurement mode. The device changes back to measurement mode automatically in 1 minute after programming through HART communication has been finished or discontinued.

5.4. Parameters –Description and programming

5.4.1. Measurement Configuration

P00: - c b a Application/Engineering Units

FACTORY DEFAULT: 001

ATTENTION!

Programming of this parameter will result in loading the factory default with the corresponding engineering units.

a	OPERATING (MEASUREMENT) MODE
1	Free flowing solids level measurement

b	ENGINEERING UNITS (ACCORDING TO „C”)	
	Metric	US
0	m	ft
1	cm	Inch

c	CALCULATION SYSTEM
0	Metric
1	US

DEVICE CAN BE OPERATED WITH TWO DIFFERENT ENGINEERING UNIT SYSTEMS, BUT FOR THE SAKE OF EASY OVERVIEW ONLY THE METRIC SYSTEM WILL BE USED!

Values transmitted by HART protocol, current output and the switching points of the relays will be interpreted into the engineering units of the (measured or calculated) process value corresponding to the programmed measurement mode. On the other hand, the higher the "a" of the programmed parameter value the more (measured or calculated) process values can be transmitted through HART (e.g., if P01=0 only the Distance, if P01=4 Distance, Level and Volume; Exception: P01=2 or 4.) (P10, P11)

a	MEASUREMENT MODE	TRANSMITTED PROCESS VARIABLES	PRIMARY VARIABLES TRANSMITTED THROUGH HART	OTHER VARIABLES TRANSMITTED THROUGH HART
0	Distance	Distance	DIST	Secondary: LEV Tertiary: DIST Quaternary: Temp
1	Level	Level	LEV	
2	Level in percent		LEV%	
3	Volume	Volume	VOL	
4	Volume in percent		VOL%	

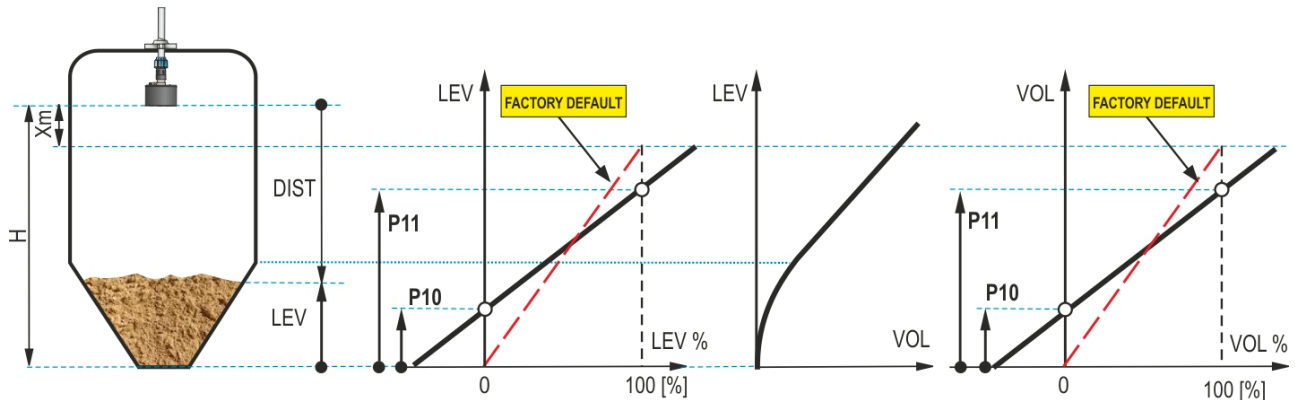

P02: - c b a Calculation units

FACTORY DEFAULT: 000

a	TEMPERATURE
0	°C
1	°F

b	Volume		Weight (set also P32)	
	Metric	US	Metric	US
0	m ³	ft ³	ton	lb (pound)
1	liter	gallon	ton	ton

This table is interpreted according to **P00(c)**, **P01(a)** and **P02(c)** and is irrelevant in case of percentage measurement (**P01(a)= 2 or 4**)

c	The value of character c has no significance at devices for solids
---	---

P03: - - - a Values displayed – Rounding (Not used at EasyTREK)

P04 - - - - Maximum measuring distance (H)

FACTORY DEFAULT: distance of XM as per table above

This parameter must always be programmed, except for distance measurement!

Maximum measuring distance is the greatest distance (**H**) between the sensor surface and the farthest surface to be measured in the application. Factory default of this parameter is the **maximum distance (X_M) that can be measured by the unit**. (See table below) During programming **P04** should be set for the **maximum distance (H) to be measured**, whereas **H ≤ X_M**.

EASYTREK	MAXIMUM MEASURING DISTANCE (X _M) [m / ft]
SCD – 34□ – □	15 / 50
SCD – 33□ – □	30 / 100
SCD – 31□ – □	60 / 200

Keep in mind that **LEVEL** (as the result of the measurement) = **P04** (programmed)
 – **DISTANCE** (measured by the device)
 Since the accuracy of level (and all further calculated) value depends on the accuracy of the max measuring distance of the application which is the distance between the sensor face and the tank / silo bottom.
 To obtain the best accuracy for liquid level measurement, measure with EasyTREK this distance in the empty tank.

P05: - - - Minimum measuring distance (Close-end blocking) FACTORY DEFAULT: automatic close end blocking (X_m as per the table)

Basic feature of the ultrasound level meters is they're not being able to measure next to the sensor surface. Within this range the measurement cannot be interpreted, thus it should be avoided that material level get into this range. By entering a value, higher than the factory default, the minimum measuring range will be extended and fixed to that value. Manual close-end-blocking would be used for example to block out the echo originating from the bottom rim of a stand-off pipe or from any object protruding into the ultrasonic cone near to the transmitter.

Automatic Close-end-blocking (Automatic Dead Band control) $P05=X_m$

By using the factory default value, the unit will automatically be adjusted to the smallest possible dead band (X_m). In ideal cases this can be smaller and in disadvantageous mountings greater than the dead band.

Manual close-end-blocking $P05 = X_B > X_m$

Entering greater value in **P05** than X_m will represent the extension of the close end blocking.

EASYTREK LEVEL TRANSMITTER FOR SOLIDS	MINIMUM MEASURING DISTANCE (X_m) [m / ft]
SCD – 34□ – □	0.6 / 2
SCD – 33□ – □	0.6 / 2
SCD – 31□ – □	1 / 3.3

P06: - - - - Far-end blocking

FACTORY DEFAULT: 0

Far-end blocking is the range below the level set in parameter **P06**. Far-end blocking can be used to avoid disturbing effects of stirrers or heaters at the bottom of the tanks. When the unit detects echoes in this range it gives special signals.

When level sinks below far-end blocking:

- Message of **"Sub 0"** appears in EView (in level and volume measurement mode)
- Current output holds value corresponding to far-end blocking distance

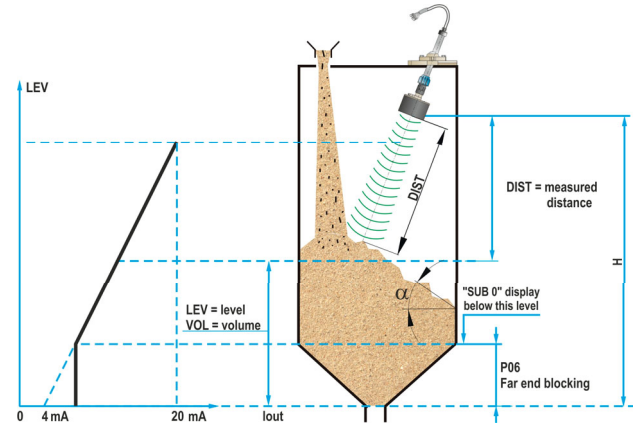

When level rises above far-end blocking:

The calculation of level and volume will be based on the programmed tank dimensions, therefore the measured or calculated process values will not be influenced in any way, by the value of far-end blocking.

5.4.2. Current value

P08: - - - Fixed output current

FACTORY DEFAULT: 0

With this step the output current can be set as a fix value, selected between 3.8 mA and 20.5 mA. Output current will be fixed until the value of P08 is programmed back to 0 again.

P10: - - - Value (of distance, level or volume) assigned to 4 mA current output

FACTORY DEFAULT: 0

P11: - - - Value (of distance, level or volume) assigned to 20 mA current output

**FACTORY DEFAULT: XM – Xm
(See P04 and P05)**

Values are interpreted according to **P01(a)**. Please note that in case of programming for (LEV or VOL) % measurement the min and max value has to be entered in the relevant engineering units of LEV (m, ft) or VOL (m³, ft³).

Assignments can be made so that the proportion between the change of the (measured or calculated) process value and the change of the current output be either direct or inverse. E.g., lev 1m (3.3 ft) assigned to 4 mA and lev 10 m (33 ft) assigned to 20 mA represents direct proportion and lev 1 m (3.3 ft) assigned to 20 mA and lev 10 m (33 ft) assigned to 4 mA represents inverse proportion.

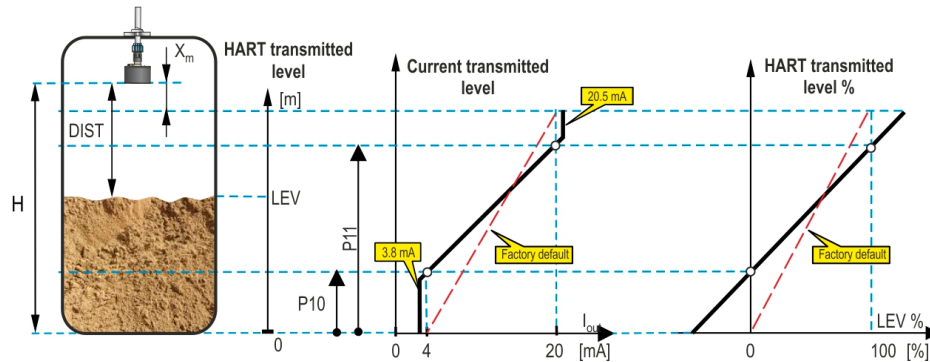

P12: - - - a Error indication by the current output

Factory Default: 0

In case of error the EasyTREK will provide one of the current outputs below for the time the failure prevails.

a	OUTPUT CURRENT AT ERROR INDICATION
0	HOLD last value
1	3.6 mA
2	22 mA

5.4.3. Relay output

P13: --- a Relay functions **FACTORY DEFAULT: 2**

a	RELAY FUNCTIONS		PARAMETERS TO BE PROGRAMMED
0	DIFFERENTIAL LEVEL CONTROL (Hysteresis control)	If the value selected for controlling the relay increases over P14 : relay energizes decreases below P15 : relay de-energizes	P14, P15 Keep at least 20 mm (0.79 inch) difference between P14 and P15
1	ERROR INDICATION	"no ECHO" indicated by energized relay	—
2		"no ECHO" indicated by de-energized relay	—

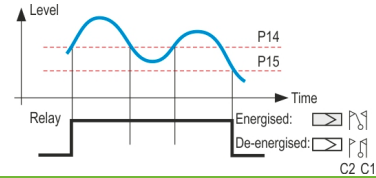

P14: ---- Relay parameter – Setpoint value **FACTORY DEFAULT: 0**

P15: ---- Relay parameter – Setpoint value **FACTORY DEFAULT: 0**

Relay set points are to be programmed for two-point control. Values should be set in the quantity selected for transmitting in parameter P01. Keep at least 20 mm (0.79 inch) difference between P14 and P15.

P19: --- a HART short address **FACTORY DEFAULT: 0**

Short address is to enter here. The 00 short address is suitable for loop with one device only, when both analogue signal and HART is able to carry information. For other settings see instruction in the manual for the configuration software EView supplied with the unit.

5.4.4. Measurement optimization

P20: --- a Damping

FACTORY DEFAULT: 7

This parameter can be used for reduction of unwanted fluctuation of the displayed value and the output.

a	Damping time [s]	Granules	DUST
		particle size >2-3 mm (0.08-0.118 inch)	particle size < 1-2 mm (0.04-0.08 inch)
0	NONE	FOR TEST ONLY	
1	3	Not recommended	Not recommended
2	6	Not recommended	Not recommended
3	10	Not recommended	Not recommended
4	30	Applicable	Not recommended
5	60	Recommended	Applicable
6	100	Recommended	Recommended
7	300	Recommended	Recommended
8	600	Recommended	Recommended
9	1000	Applicable	Applicable

P23: --- a Angle of repose (repose formation)

FACTORY DEFAULT: 0

This parameter is important for the optimisation of the of the **QUEST+** software echo evaluation.

The optimal setting of this parameter can be done with the help of checking the echo strength in the read-out parameter **P72** indicating the echo amplitude in dB.

*The ideal setting of **P23** is at which the parameter value in **P72** becomes the best (nearest "0").*

a	Estimated angle of repose
0	No angle of repose $\alpha \cong 0$
1	$\alpha < 15^\circ$
2	$\alpha > 15^\circ$

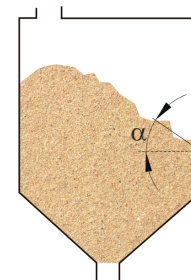

P24: - - - a Target tracking speed**FACTORY DEFAULT: 0**

With this parameter the evaluation can be sped up at the expense of the accuracy.

a	Tracking speed	Remark
0	Standard	For most applications
1	Fast	For fast changing level
2	Special	For very special cases only, as this reduces the maximum measuring range to 50% of the nominal value! The measuring window (P25 and P33) is inactive and the EasyTREK will respond practically instantly to any target.

P25: - - - a Selection of Echo within the measuring window**FACTORY DEFAULT: 0**

A so-called measuring window is formed around the echo signal. The position of this measuring window determines the flight time for calculation of the distance of the target. (the picture below can be seen on the test oscilloscope).

Some applications involve multiple (target + disturbing) echoes even within the measuring window. Basic echo selection will be done by the Quest + software automatically. This parameter only influences the echo selection within the measuring window.

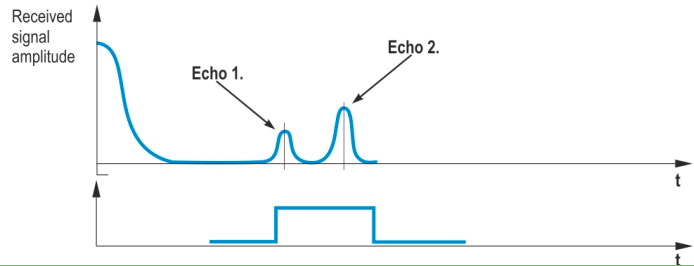

a	Echo in the window to be selected	Remarks
0	With the highest amplitude	For most applications (both liquids and solids)
1	First one	For applications with multiple echoes within the Measuring Window
2	Largest one	Recommended for applications with floating material in the air

P26: - - - - Level elevation rate (filling speed) [m/h]**FACTORY DEFAULT: 500****P27: - - - - Level wane rate (emptying speed) [m/h]****FACTORY DEFAULT: 500**

Use these parameters to provide additional protection against echo loss in applications involving dust during the filling process (powders, dusting granules). Reliability of the measurement can be enhanced by the correct setting of this parameter.

These parameters must not be smaller than the fastest possible filling/emptying rate of the actual technology.

Caution! In tanks with a conical or pyramidal bottom, the rate of change of level at the bottom of the tank increases significantly.

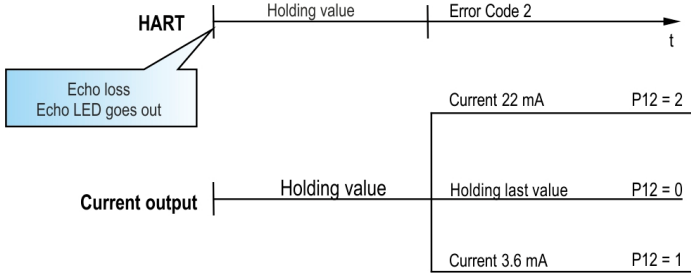
a	ECHO-LOSS ERROR INDICATION	REMARK
0	Delayed	<p>During short periods of echo-loss, both Eview and the analogue output will hold last value. The current output holds last value for twice as long as set in P20 before going to the "Error Indication Mode" set in P12.</p> 
1	None	During an echo-loss the displayed value on the EView and the analogue output value will hold last value.
2	Advance to full	When echo-loss occurs during filling, the displayed value on the EView and the analogue output value shifts towards the "full" tank/silo state with the level elevation rate (filling speed) set in P26
3	Immediate	In case of an echo-loss, 'no Echo' will appear in EView and the outputs will change according to the "Error Indication Mode" set in P12 .
4	No echo-loss indication in case of empty tank/silo	Echo-loss may occur in completely empty tanks with a spherical bottom due to deflection of the ultrasonic beam, or in case of silos with an open outlet. If the echo is lost when the tank/silo is completely empty, the indication will correspond to empty tank, in all other cases echo-loss indication will function according to the "Delayed".

P29 - - - - Blocking out of object **FACTORY DEFAULT: 0**

One object in the tank/silo disturbing measurement can be blocked out. Enter distance of the object from the transducer. Use the Echo Map (P70) to read out the precise distance of disturbing objects.

P31: - - - - Sound velocity at +20 °C (+68 °F) [m/s or ft/s] **FACTORY DEFAULT: metric: 343.8 m/s, US: 1128 ft/s**

Use this parameter if the sound velocity in the gases above the measured surface differs largely from that of in air. Recommended for applications where the gas is more or less homogeneous. If it is not, the accuracy of the measurement can be improved using the 32-point linearization (P48, P49).
For sound velocities in various gases see section "Sound Velocities".

P32: - - - - Specific gravity [kg/dm³] **FACTORY DEFAULT: 0**

If you enter value (other than "0") of specific gravity in this parameter, the weight will be displayed in EView instead of VOL.

P33: - - - - Manual echo selection by moving the Measuring Window **FACTORY DEFAULT: 0**

A so-called measuring window is formed around the echo signal (See scheme on the next page.). The distance of the target will be calculated from the flight time in accordance with the position of the measuring window.

Use this parameter if the EasyTREK unambiguously selects a wrong echo; for example, the echo reflected from the surface is much weaker than the interfering one(s) (see figure beside and on next page).

Enter the distance of the correct echo and the software will move the measuring window and calibrate itself to the echo found there. To determine the distance of the correct echo, either use the Echo Map (to load-in a value from the Echo Map, see parameter **P70**), or measure the distance with an appropriate device, and enter this value in **P33**.

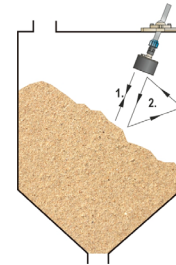

If this parameter has been used (P33 is not 0), its value will be continuously updated with the valid echo position. This means, that in case of a power loss, the EasyTREK will restart the signal processing with the measuring window at the last updated position. To switch-off this function, set **P33 = 0**.

MANUAL ECHO SELECTION

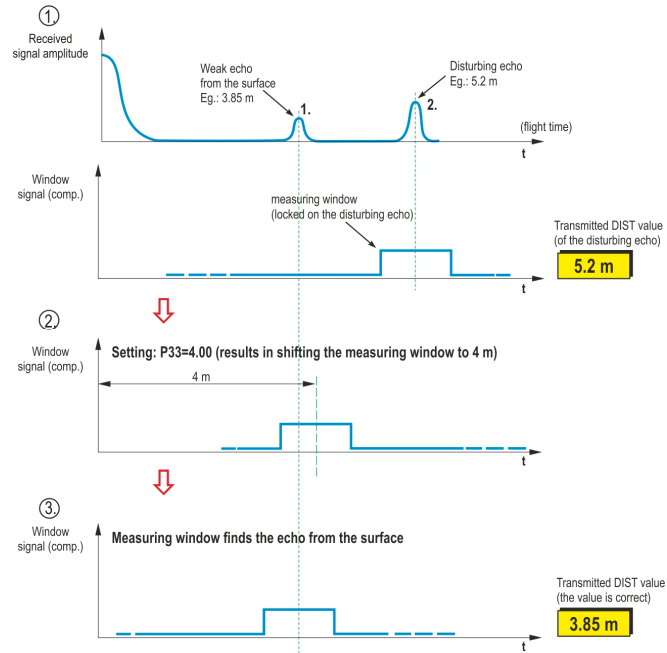

5.4.5. Volume measurement

P40: -- ba Tank / silo shape

FACTORY DEFAULT: 00

ba	Tank/silo shape	Other parameters to be set
b0	Standing cylindrical tank shape: value of "b" as below bottom	P40(b), P41
01	Standing cylindrical tank/silo with conical bottom	P41, P43, P44
02	Standing rectangular tank/silo (with chute)	P41, P42, P43, P44, P45
b3	Lying cylindrical tank shape: value of "b" as below bottom	P40(b), P41, P42
04	Spherical tank	P41

Caution!

The value "a" defining the shape of the container must be set first.

P41-45: - - - Tank / silo dimensions

FACTORY DEFAULT: P41 ... P45 = 0

Standing cylindrical tank/silo
with hemispherical bottom a = 0

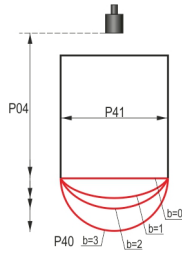

Standing cylindrical tank/silo
with conical bottom a = 1, b = 0

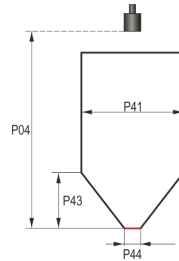

Standing rectangular tank/silo
with or without chute a = 2, b = 0

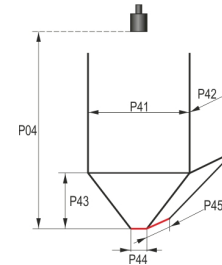

For flat bottom
P43, P44 and
P45 = 0

Lying cylindrical tank a = 3

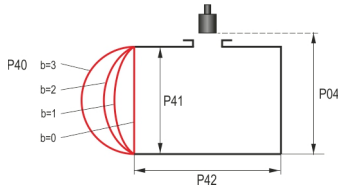

Spherical tank a = 4, b = 0

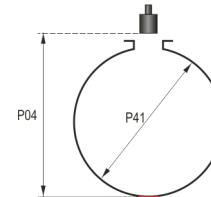

5.4.6. Linearisation

P47: - - a Linearization

FACTORY DEFAULT: 0

An output signal of any characteristic can be assigned to the level values measured by the device. The characteristic can be specified with a maximum of 32 points. The device calculates the output signal from the measured level between the points by linear interpolation.

Programming example: Measured level \Rightarrow can be used to assign any output signal or to calculate the level \Rightarrow volume for a tank that is not in the tank shape selection (e.g.: dented).

a	Linearization
0	OFF (FACTORY DEFAULT)
1	ON

P48: - - - - Number of linearization data pairs**FACTORY DEFAULT: $L(i) = 0$ $r(i) = 0$**

The data pairs defining the characteristic points must be entered into a table of three columns. The table can be filled with pre-calculated data or data measured while filling the tank. Column L shows the measured level (LEV) values. Column “r” shows the output values assigned to the measured level (as per P01 (a)).

i	L (Left column) Level values measured	r (Right column) Value assigned to transmit
1	0	r(1)
2	L(2)	r(2)
	L(i)	r(i)
nn	L(nn)	r(nn)
nn+1	0	0
32	0	0

Conditions of correct programming of the data pairs

- The table must always start with: $L(1) = 0$ and $r(1) =$ value (assigned to 0 level)
- Column L cannot contain the same values.
- If the table contains less than 32 data pairs, the row after the last valuable data pair in column L must be 0.
- If the above conditions are not met and $P47 = 1$ (table active), an error code will be displayed (see chapter: Error Codes).

Note: *for further information about programming in reference to linearization see user's manual of the EView software and MultiCONT process controller*

5.4.7. Informational parameters**P60: - - - - Overall operating hours of the unit [h]****P61: - - - - Time elapsed since last switch-on [h]****P62: - - - - Operating hours of the relay [h]****P63: - - - - Number of switching cycles of the relay****P64: - - - - Actual temperature of the transducer [°C]**

Broken loop of the thermometer will be indicated by Pt Error message that is initiated by a signal sent via HART. In this case the transmitter will perform temperature correction corresponding to +20 °C (+68 °F).

P65: - - - - Maximum temperature of the transducer [°C]

P66: - - - - Minimum temperature of the transducer [°C]

P70: Number of Echoes / Echo Map (separate menu item or highlighted window)

Entering this parameter the level transmitter stores the actual echo map, the amplitude and the position of the echoes. The distance and amplitude of these echoes can be read-out one by one in ascending order. The selected echo is marked. **Note:** for graphic display of the echoes use the EView software or a MultiCONT process controller.

P71: - - - - Distance of the of Measuring Window (DIST) [m]

P72 - - - - Amplitude of the selected echo [dB] (< 0)

If the echo map is empty, **NoECHO** is displayed.

P73: - - - - Position of the selected echo (time) [ms]

P74: - - - - Signal to Noise Ratio

RATIO	MEASUREMENT CONDITIONS
Over 70	Excellent
Between 70 and 50	Good
Under 50	Unreliable

P75: - - - - Blocking Distance

This parameter gives information about the actual close-end blocking distance (provided automatic blocking was selected in **P05**)

5.4.8. Test parameters

P96: - - - - Checksum

P97: - - - - Software code

P98: - - - - Hardware code

P99: - - - - Access lock by secret code

The purpose of this feature is to provide protection against accidental programming of parameters or by a person. not entitled. The secret code can be any value other than **0000**. Setting a secret code will automatically be activated when the EasyTREK is returned to the Measurement Mode. In order to program locked device, the secret code should be entered first in **P99**. Thus, for entering a new code or erasing the old one the knowledge of the previous code is necessary.

5.4.9. Error codes

Error Code	Error description	Causes and actions to be done
Err 1	Memory error	Contact local agent
noEc or Err 2	Echo loss or echo too weak to evaluate	Bad reflection from the surface, reflection not directed towards the sensor, due to dusting excessive sound absorption. Check device selection and/or adjustment
Err 3	Hardware error	Contact local agent
Err 4	Calculation overflow	Check settings
Err 5	Code referring to sensor error or improper installation/mounting, level in the dead band	Verify sensor for correct operation and check for correct mounting according to User's Manual
Err 6	The measurement is at the reliability threshold	Change aiming or try to find a better location
Err 7	No signal received within the measuring range specified in P04 and P05.	Review programming, also look for installation mistake
Err 12	Linearisation table error: L(1) and L(2) are both zero (no valid data-pairs)	See the Section "Linearisation"
Err 13	Linearisation table error: there are two same L(i) data in the table	See the Section "Linearisation"
Err 14	Linearisation table error: the r(i) values are not monotone increasing	See the Section "Linearisation"
Err 15	Linearisation table error: measured Level is higher than the last Volume or Flow data-pair	See the Section "Linearisation"
Err 16	The checksum of the program in the EEPROM is wrong	Contact local agent

6. MAINTENANCE, REPAIR

The device does not require regular maintenance. In case dust adheres to the face of the sensor despite the self-cleaning of the sensor face through resonance, (e.g.: static build-up) it can be cleaned by pressurized air.

The warranty card contains the terms and conditions. Before returning the device for repairs, it must be cleaned thoroughly. The parts in contact with the medium may contain harmful substances; therefore, they must be decontaminated. Our official form ([Returned Equipment Handling Form](#)) must be filled and enclosed in the parcel. Download it from our website www.nivelco.com. The device must be sent back with a declaration of decontamination. A statement must be provided in the declaration that the decontamination process was successfully completed and that the device is clean from any hazardous substances.

7. STORAGE CONDITIONS

Ambient temperature: -30...+60 °C (-22...+140 °F)

Relative humidity: max. 98 %

8. PARAMETER TABLE

Par.	Page	Description	Value				Par.	Page	Description	Value			
			d	c	b	a				d	c	b	a
P00	15	Application/Engineering Units					P28	24	Echo-loss handling				
P01	16	Measurement Mode					P29	25	Blocking out of object				
P02	17	Calculation units					P30						
P03	17	Values displayed - Rounding					P31	25	Sound velocity at +20 °C (+68 °F)				
P04	17	Maximum Measuring Distance					P32						
P05	18	Minimum Measuring Distance					P33	25	Specific gravity				
P06	19	Far End Blocking					P34	25	Manual echo selection				
P07	-	-					P35	-	-				
P08	20	Fixed output current					P36	-	-				
P09	-	-					P37	-	-				
P10	20	Value assigned to 4 mA current output					P38	-	-				
P11	20	Value assigned to 20 mA current output					P39	-	-				
P12	20	Error indication by the current output					P40	26	Tank / silo shape				
P13	21	Relay functions					P41	27	Tank / silo dimensions				
P14	21	Relay parameter – Setpoint value					P42	27	Tank / silo dimensions				
P15	21	Relay parameter – Setpoint value					P43	27	Tank / silo dimensions				
P16	-	-					P44	27	Tank / silo dimensions				
P17	-	-					P45	27	Tank / silo dimensions				
P18	-	-					P46						
P19	21	HART short address					P47	27	Linearization				
P20	22	Damping					P48	28	Number of linearization data pairs				
P21	-	-					P49	-	-				
P22							P50	-	-				
P23	22	Angle of repose					P51	-	-				
P24	23	Target tracking speed					P52	-	-				
P25	23	Selection of Echo in the measuring window					P53	-	-				
P26	23	Level elevation rate					P54	-	-				
P27	23	Level descent rate					P55	-	-				

Par.	Page	Description	Value				Par.	Page	Description	Value			
			d	c	b	a				d	c	b	a
P56	-						P78	-					
P57	-						P79	-					
P58	-						P80	-					
P59	-						P81	-					
P60	28	Overall operating hours of the unit					P82	-					
P61	28	Time elapsed since last switch-on					P83	-					
P62	28	Operating hours of the relay											
P63	28	Number of switching cycles of the relay											
P64	28	Actual temperature of the transducer											
P65	29	Maximum temperature of the transducer											
P66	29	Minimum temperature of the transducer					P88	-					
P67	-						P89	-					
P68	-						P90	-					
P69	-						P91	-					
P70	29	Number of Echoes / Echo Map					P92	-					
P71	29	Distance of the of Measuring Window					P93	-					
P72	29	Amplitude of the selected echo					P94	-					
P73	29	Position of the selected echo					P95	-					
P74	29	Signal to Noise Ratio					P96	29	Checksum				
P75	29	Blocking Distance					P97	29	Software code				
P76	-						P98	29	Hardware code				
P77	-						P99	29	Access lock by secret code				

scd340en21p07

December 2021

NIVELCO reserves the right to change anything in this manual without notice!.