

EchoTREK

ST/SB-400 series four-wire
compact ultrasonic level transmitters

Installation and Programming Manual
2nd edition



Manufacturer:

NIVELCO Process Control Co.

H-1043 Budapest, Dugonics u. 11.

Tel.: (36-1) 889-0100 ■ Fax: (36-1) 889-0200

E-mail: sales@nivelco.com ■ www.nivelco.com

BASIC CONCEPTS AND ELEMENTS

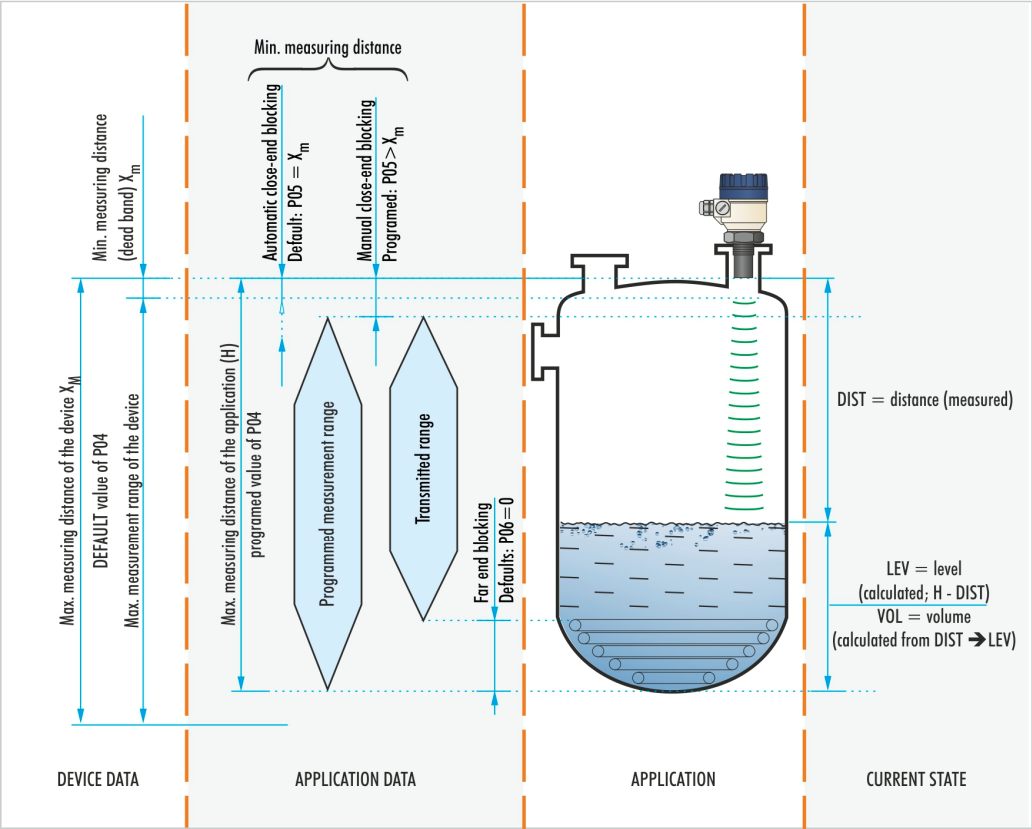

CONTENTS

1. INTRODUCTION	5	6. PARAMETERS – DESCRIPTIONS AND PROGRAMMING	27
2. ORDER CODES	6	6.1 MEASUREMENT CONFIGURATION	27
3. TECHNICAL DATA	7	6.2 CURRENT OUTPUT	33
3.1 ACCESSORIES	10	6.3 RELAY OUTPUT	34
3.2 MAINTENANCE AND REPAIR	11	6.4 MEASUREMENT OPTIMISATION	35
3.2.1 Software upgrade	11	6.5 DATA LOGGER	39
4. INSTALLATION	12	6.5.1 READING DATA OUT FROM THE LOGGER	42
4.1 LIQUID LEVEL MEASUREMENT	12	6.6 VOLUME MEASUREMENT	43
4.2 OPEN CHANNEL FLOW MEASUREMENT	14	6.7 VOLUME FLOW MEASURING	44
4.3 INSTALLATION AND ELECTRICAL CONNECTION	14	6.8 32-POINT LINEARISATION	50
5. PROGRAMMING	16	6.9 INFORMATIONAL PARAMETERS (READ OUT PARAMETERS)	51
5.1 PROGRAMMING WITHOUT DISPLAY MODULE	17	6.10 ADDITIONAL PARAMETERS OF THE FLOW METERING	53
5.2 PROGRAMMING WITH THE SAP-200 DISPLAY MODULE	20	6.11 SUPPLEMENTARY PARAMETER OF THE LOGGER	53
5.2.1 SAP-200 Display Module	21	6.12 TEST PARAMETERS	54
5.2.2 Steps of the SAP-200 Display Module	21	6.13 SIMULATION	55
5.2.3 Indications of the SAP-200 and LED Status	22	6.14 ACCESS LOCK	55
5.2.4 QUICKSET	23	7. ERROR CODES	56
5.2.5 Full Parameter Access	25	8. PARAMETER TABLE	57
		9. SOUND VELOCITIES IN DIFFERENT GASES	59



**Thank you for choosing a NIVELCO instrument.
We are sure that you will be satisfied throughout its use.**

1. INTRODUCTION

Application

The **EchoTREK** compact ultrasonic level transmitters from NIVELCO are an excellent tool for the level measurement of liquids.

Level measurement technology based on the non-contacting ultrasonic principle is especially suited for applications where, for any reason, no physical contact can be established to the surface of the material to be measured.

Such reasons may include corrosive attack by the process medium against the measuring device material (acids), possible contamination (sewage) or particles of the process medium adhering to the measuring device (adhesive materials).

Principle of Operation

The ultrasonic level metering technology is based on the principle of measuring the time required for the ultrasound pulses to make a round trip from the sensor to the level to be measured and back. The sensor emits an ultrasonic pulse train and receives the echoes reflected. The intelligent electronic device processes the received signal by selecting the echo reflected by the surface and calculates from the time of flight the distance between the sensor and the surface which constitutes the basis of all output signals of the EchoTREK

Minimum measuring distance (X_m) is determined by the design of the unit within which the measurement is not possible (Dead Zone). This distance can be extended by programming in order to avoid disturbing effects of possible disturbing echoes coming from fixed objects. (Close-end Blocking).

Maximum measuring distance (X_M) is the greatest distance (determined by the design of the unit) which can be measured by the unit under ideal conditions. The maximum measuring distance of the actual application (H) must not be greater than X_M .

A Total beam angle of 5...7° at -3 dB as is featured by most of NIVELCO's SenSonic transducers ensuring a reliable measurement in narrow silos with uneven side walls as well as in process tanks with various protruding objects. Furthermore, as a result of the narrow beam angle – the emitted ultrasonic signals have an outstanding focusing – deep penetration through gases, vapor and foam is ensured.

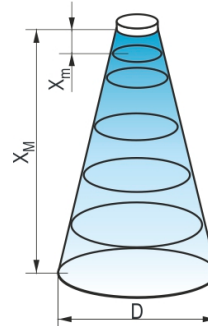

X	D
1 m	– 0.21 m
2 m	– 0.3 m
5 m	– 0.56 m
10 m	– 1 m
15 m	– 1.45 m

Diameters
corresponding to
5° beam angle.

Dead Band is a feature common to all ultrasonic level meters.

It is specified as “Minimum measuring distance” in the Technical Data Table. Measurement within this range can not be interpreted.

2. ORDER CODES

Note: not all combinations are possible

EchoTREK S - 4 -

TYPE	CODE	TRANSDUCER / HOUSING	CODE	MEASURING RANGE *	CODE	MOUNTING	CODE	OUTPUT	CODE
Transmitter	T	PP / Aluminum	A	25 m	2	BSP thread	0	4...20 mA + R1+R2 / 230 V AC	1
Transmitter with local indicator	B	PVDF / Aluminum	B	12; 15 m	4	NPT thread	N	4...20 mA + R1+R2 / 24 V AC / DC	2
		PTFE / Aluminum	T	7; 10 m	6	DN80 PN16 / PP	2	4...20 mA + R1+R2 + HART / 230 V AC	3
		SS316Ti / Aluminum	S	6; 8 m	7	DN100 PN16 / PP	3	4...20 mA + R1+R2 + HART / 24 V AC / DC	4
		PP / Plastic	P	5; 6 m	8	DN125 PN16 / PP	4	4...20 mA + R1+R2 + HART + Logger / 230 V AC	G
		PVDF / Plastic	V	3; 4 m	9	DN150 PN16 / PP	5	4...20 mA + R1+R2 + HART + Logger / 24 V AC / DC	H
		PTFE / Plastic	F			DN200 PN16 / PP	6	4...20 mA + R1+R2 + Logger / 230 V AC	K
		SS316Ti / Plastic	M			200 mm bracket	K	4...20 mA + R1+R2 + Logger / 24 V AC / DC	L
						500 mm bracket	L		
						700 mm bracket	M		

* Measuring range depends on the material of the transducer

3. TECHNICAL DATA

GENERAL DATA

Transducer materials	Polypropylene (PP) Kynar (PVDF) Teflon (PTFE) Stainless Steel (DIN 1.4571, AISI SS316Ti)
Housing material	Plastic: Glass fiber plastic PBT (DuPont®) Aluminum: Powder paint coated
Process temperature	PP, PVDF and PTFE transducers: -30...+90 °C Stainless Steel transducer: -30...+100 °C (120 °C for max. 2 hours)
Ambient temperature	Plastic housing: -25...+70 °C Aluminum housing: -30...+70 °C with display -25...+70 °C
Pressure** (Absolute)	0.5...3 bar (0.05...0.3 MPa) Stainless steel versions 0.9...1.1 bar (0.09...0.11 MPa)
Seals	PP transducer: EPDM All other transducer versions: FPM (Viton®)
Ingress protection	Sensor: IP68 Housing: IP67 (NEMA 6)
Power supply	230 V AC type: 85...255 V AC / 2 VA, 24 V AC/DC type: 24 V ±15% AC/DC / 100 mA galvanic isolation; protection against surge transients
Accuracy *	± (0.2% of the measured distance plus 0.05% of the range)
Resolution	Depending on the measured distance < 2 m: 1 mm, 2...5 m: 2 mm, 5...10 m: 5 mm, > 10 m: 10 mm
Outputs	Analogue: 4...20 mA (3.9...20.5 mA), $R_{Lmax} = 600 \Omega$ isolated protection against surge transients
	SPDT relay 1: 250 V AC / 3 A AC1
	SPDT relay 2: 30 V DC, 1 A DC
	Display: 6-digits, icons and bargraph, (on SAP-200 display module on the ST version only) Serial communication: HART interface (terminal resistor 250 Ω)
Electrical connection	M20x1.5 Plastic, Cable \varnothing 6...12 mm 2x 1/2" NPT for cable gland; Wire cross section: 0.5...1.5 mm ²
Electrical protection	SELV: Protection Class III Mains: Protection Class I (Aluminum housing) Protection Class II (Plastic housing)

* Under optimal circumstances of reflection and stabilized transducer temperature.

** For pressures below 1 bar representative of NIVELCO should be consulted.

SPECIAL DATA OF THE 4-WIRE EchoTREK WITH PP AND PVDF TRANSDUCERS

TYPE	ST□-49□-□ SB□-49□-□	ST□-48□-□ SB□-48□-□	ST□-47□-□ SB□-47□-□	ST□-46□-□ SB□-46□-□	ST□-44□-□ SB□-44□-□	ST□-42□-□ SB□-42□-□
Transducer material	PP / PVDF					
Maximum measuring distance* [m / ft]	4	6	8	10	15	25
Min. measuring distance* (Dead band) [m / ft]	0.2	0.25	0.35	0.35	0.45	0.6
Total beam angle (-3 dB)	6°	5°	7°	5°	5°	7°
Measurement frequency	80 kHz	80 kHz	50 kHz	60 kHz	40 kHz	20 kHz
Process connection	1½" thread	2" thread	2" thread	DN80 Flange	DN125 Flange	DN150 Flange

* (from the transducer face)

SPECIAL DATA OF THE 4-WIRE EchoTREK PTFE AND STAINLESS STEEL TRANSDUCERS

TYPE	ST□-49□-□ SB□-49□-□	ST□-48□-□ SB□-48□-□	ST□-47□-□ SB□-47□-□	ST□-46□-□ SB□-46□-□	ST□-44□-□ SB□-44□-□	ST□-42□-□ SB□-42□-□
Transducer material	PTFE			SS316 Ti		
Maximum measuring distance* [m/ft]	3	5	6	7	12	15
Min. measuring distance* (Dead band) [m/ft]	0.25	0.25	0.35	0.4	0.55	0.65
Total beam angle (-3 dB)	6°	5°	7°	5°	5°	7°
Measurement frequency	80 kHz	80 kHz	50 kHz	60 kHz	40 kHz	40 kHz
Process connection	1½" thread	2" thread	2" thread	DN80 Flange	DN125 Flange	DN150 Flange

* (from transducer face)

SAP-200 DISPLAY MODULE

Field indication	6-digits Custom LCD, icons and bargraph
Ambient temperature	-25...+70 °C
Housing material	PBT fiber-glass reinforced plastic, (DuPont®)

Dimensions of the 4-wire EchoTREK

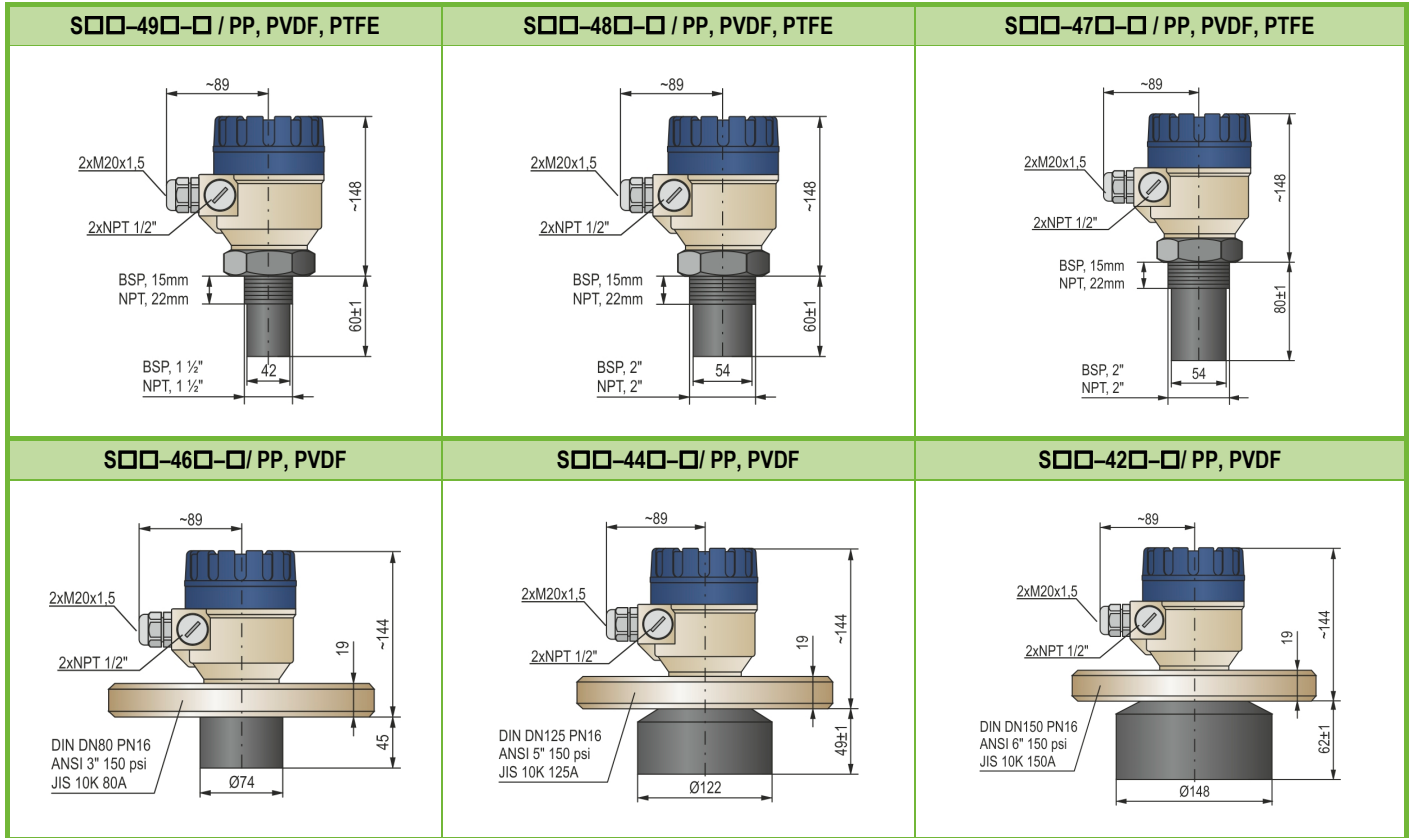

* Min required flange size

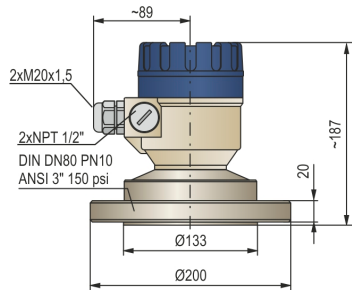
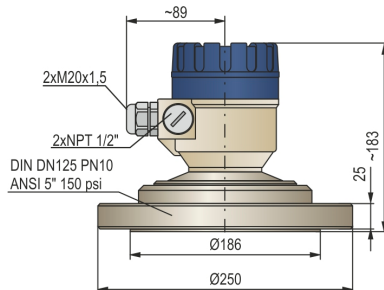
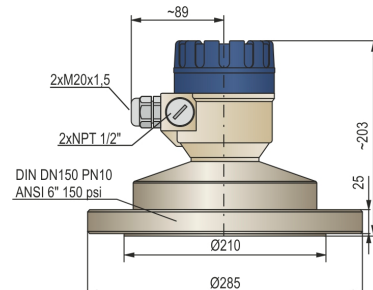
S□S-46□-□/ SS316Ti**S□S-44□-□/ SS316Ti****S□S-42□-□/ SS316Ti**

3.1 ACCESSORIES

- Certificate of Warranty
- Installation and Programming Manual
- EU Declaration of Conformity
- 2× M20x1.5 cable gland
- SAP-200 Display Module (option)

3.2 MAINTENANCE AND REPAIR

The device does not require regular maintenance. The warranty card contains the terms and conditions. Before returning the device for repairs, it must be cleaned thoroughly. The parts in contact with the medium may contain harmful substances; therefore, they must be decontaminated. Our official form ([Returned Equipment Handling Form](#)) must be filled and enclosed in the parcel. Download it from our website www.nivelco.com. The device must be sent back with a declaration of decontamination. A statement must be provided in the declaration that the decontamination process was successfully completed and that the device is clean from any hazardous substances.

3.2.1 SOFTWARE UPGRADE

Based on the observations & needs of our customers NIVELCO constantly improves and revises the operating software of the device. The software can be upgraded with the help of the IrDA communication port of the SAP-200 or an ELink (USB) communication adapter plugged into the SAP-200 slot. For more information about software updates please contact NIVELCO.

4. INSTALLATION

4.1 LIQUID LEVEL MEASUREMENT

POSITION

The optimal position of the EchoTREK is on the radius $r = (0.3 \dots 0.5) R$ of the (cylindrical) tank / silo.
(Take also sonic cone on page 1 into consideration.)

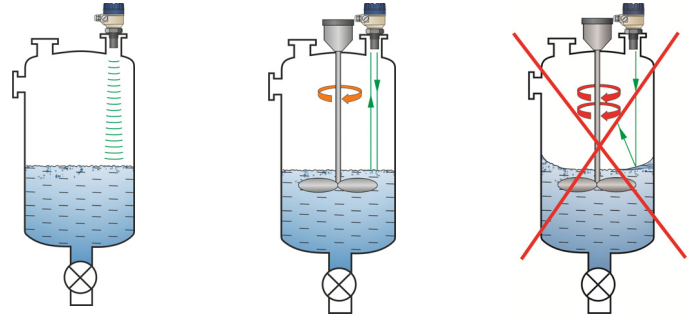

SENSOR ALIGNMENT

The sensor face has to be parallel to the surface of the liquid within $\pm 2 \dots 3^\circ$.

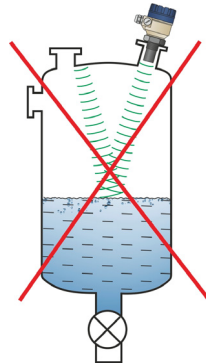

TEMPERATURE

Make sure that the transmitter will be protected against overheating by direct sunshine.

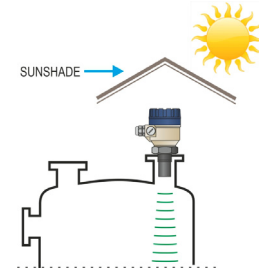

OBSTACLES

Make sure that no in-flow path or objects (e.g. cooling pipes, ladders, bracing members, thermometers, etc.) or no tank wall of the ragged surface protrude into the sensing cone of the ultrasonic beam. One fix object in the tank / silo that disturb the measurement can be blocked out by the appropriate programming of the EchoTREK

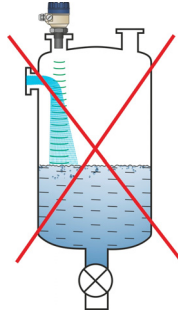

FOAM

Foaming of the liquid surface may render ultrasonic level metering impossible. If possible, a location should be found, where foaming is the least (device should be located as far as possible from liquid inflow) or a stilling pipe or well should be used.

WIND

Intensive air (gas) movements in the vicinity of the ultrasonic cone is to be avoided. A strong draft of wind may "blow away" the ultrasound. Devices with lower measuring frequency (40, 20 kHz) are recommended.

FUMES / VAPOURS

For closed tanks containing chemicals or other liquids, which creates fume/gases above the liquid surface especially for outdoor tanks exposed to the sun, a strong reduction of the nominal measuring range of the ultrasonic device is to be considered during device selection. Devices with lower measuring frequency (40, 20 kHz) are recommended in these cases units.

STAND-OFF PIPE

The structure of the stand off pipe should be rigid; the inner rim where the ultrasonic beam leaves the pipe should be rounded.

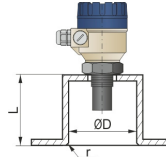

L	D _{min}		
	S□□-49□	S□□-48□	S□□-47□
150	50	60	60
200	50	60	75
250	65	65	90
300	80	75	105
350	95	85	120

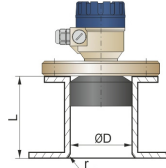

L	D _{min}	
	S□□-46□	S□□-44□
90	80	*
200	80	*
350	85	*
500	90	*

* For values contact your distributor

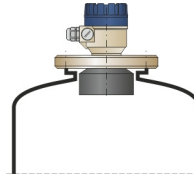

The sensor of the S□□-42□ has to be in the tank.

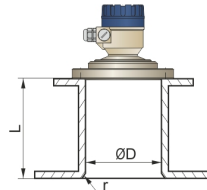

L	D _{min}		
	S□S-46□	S□S-44□	S□S-42□
320	80	-	-
440	-	125	-
800	-	-	150

4.2 OPEN CHANNEL FLOW MEASUREMENT

- For ultimate accuracy, install the sensor as close as possible above the expected maximum water level (see minimum measuring range).
- Install the device in a place defined by the characteristics of the metering channel along the longitudinal axis of the flume or weir. In case of Parshall flumes supplied by NIVELCO the location of the sensor is marked.
- In some cases foam may develop on the surface. Make sure that the surface, opposite to the sensor remain free of foam for proper sound reflection.
- From the point of view of measurement accuracy the length of the channel sections preceding and following the measuring flume and their method of joining to the measuring channel section are of critical importance.
- Despite of the most careful installation, the accuracy of flow metering will be lower than that of specified for the distance measurement. It will be determined by the features of the flume or weir applied.

4.3 INSTALLATION AND WIRING

Installation of the (BSP or NPT) threaded models

- Screw the unit in its place. Use open wrench for tightening; max torque is 20 Nm
- After tightening the enclosure can be rotated to the proper position. (Safety bolt prevents rotation more than 350°)
- The unit may be damaged by electrostatic discharge (ESD) via its terminal, thus apply the precautions commonly used to avoid electrostatic discharge e.g. by touching a properly grounded point before removing the cover of the enclosure.
- Ensure that the power supply is turned off at the source.
- With removal of the cover of the housing and taking out the display module (if any), the screw terminals can be accessed. Suggested cable core cross section: 0.5...1.5 mm².
Arrange grounding by the inner or outer grounding screw first.
- Switch on the unit and make necessary programming.
- After programming ensure proper sealing and closing of the cover.

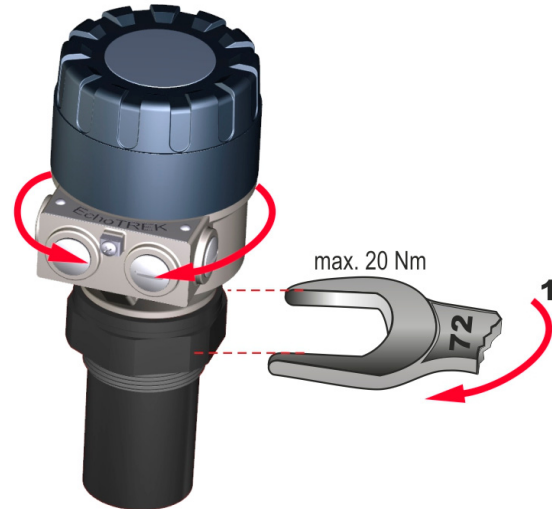

Transmitter S□□ - 4□□

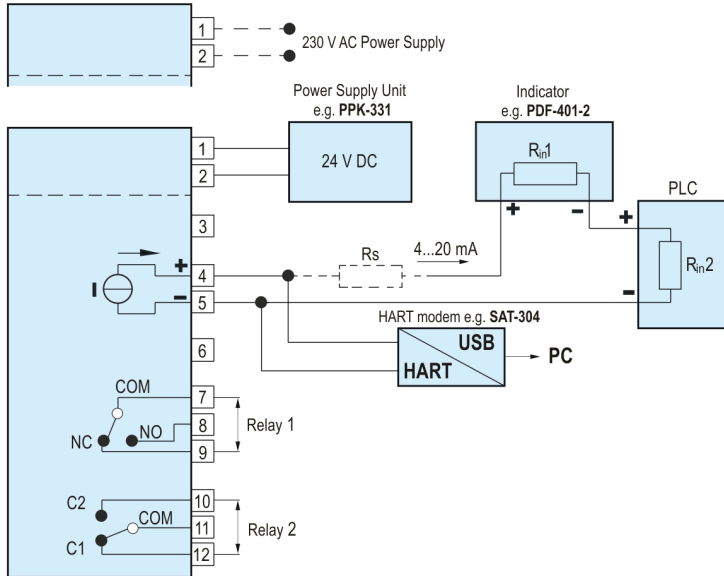

$R_s + R_{in1} + R_{in2} > 250 \Omega$ has to be, in case of using HART modem

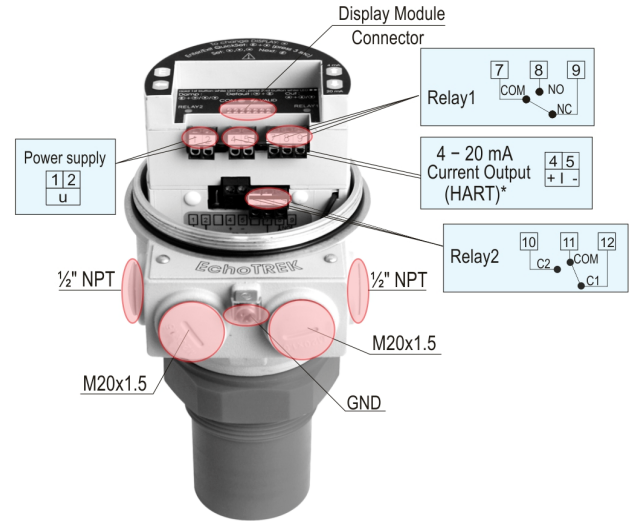

WARNING!

* For proper working the free current output has to be closed with a max. 600 Ω impedance!

5. PROGRAMMING

The EchoTREK can be programmed by the following two ways:

- **Programming** without Display Module see 5.1.
Assignment of the levels to the 4 and 20 mA current output, error indication by the analogue signal and damping can be set.
- **With the SAP-200 Display Module**, see 5.2.
All features of the unit can be set, such as measurement configuration and optimization, 32-point linearization, dimensions for 11 tanks with different shape and for 21 different open channels (flume, weir, etc.).

Devices with the type number **EchoTREK SG...** are already equipped with the SAP-200.

The EchoTREK is fully operational without the SAP-200. The SAP-200 is only needed for programming and/or displaying measurement values.

The unit will measure during programming in accordance with the previous parameters. The new, modified parameters will only be effective after returning to the Measurement Mode

If the transmitter is left in Programming Mode by mistake, it will automatically return to Measurement Mode after 30 minutes and will operate with the parameters entered during the last completed programming.

The EchoTREK will be delivered with the following **Factory Default**:

- ⇒ Current output, display and bargraph: LEVEL
- ⇒ Current output and bargraph proportional to the level
- ⇒ 4 mA: assigned to the minimum level 0%
- ⇒ 20 mA: assigned to the maximum level 100%
- ⇒ Error indication by the current output: hold last value
- ⇒ Damping: 60 sec

5.1 PROGRAMMING WITHOUT DISPLAY MODULE

Programming is only possible if the EchoTREK is in Level Measuring Mode and receives valid echo i.e. "VALID" LED is lit!

The following can be programmed without display module

- Assignment of the 4 mA to a required e.g. min. level / max. distance
- Assignment of the 20 mA to a required e.g. max. level / min. distance
- Error indication by the current output (Hold, 3.6 mA or 22 mA)
- Damping (10, 30 or 60 sec)
- Reset to the factory default

Note: Current output can also be assigned in inverted mode:
4 mA = 100% (Full), 20 mA = 0% (Empty)

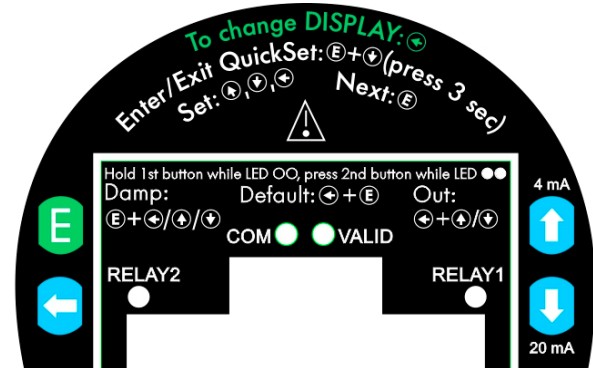

Procedure of programming: press button in the relevant sequence and check the state of the LED-s. Symbols for the states of the LED-s:
○ = LED is off, ● = LED is blinking, ●● = LED is on, ●○ = LEDs are blinking alternatively, ⊗ = Don't care

Minimum level, (0%, empty tank) assignment to 4 mA

Action	Led state following the action
1) Check for a valid ECHO	⊗●● = Valid ECHO, transmitter programmable
2) Press NEXT [Down] button steadily	○○ = EchoTREK in programming mode
3) Press UP [Up] button steadily	●● = 4 mA assigned to the distance (see picture)
4) Release buttons	○○ = Programming completed

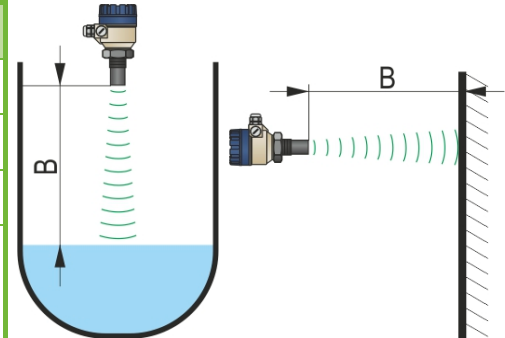

Use level in tank or a fix target e.g. the wall

Maximum level (100%, full tank) assignment to 20 mA

Action	Led state following the action
1) Check for a valid ECHO	⊗● = Valid ECHO, transmitter programmable
2) Press NEXT (↶) button steadily	○○ = EchoTREK in programming mode
3) Press DOWN (⬇) button steadily	●● = 20 mA as signed to the distance (see picture)
4) Release buttons	○○ = Programming completed

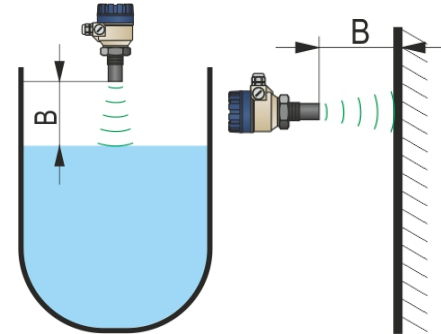

Use level in tank or a fix target e.g. the wall

“Error state” indication by the analogue signal (Check for a valid echo as above)

As a result of this setting the value of the analogue output will be 3.8 mA; 22 mA or according last value (hold) until the error is ceased.

Action	Led state following the action
1) Press (↶) button steadily	○○ = EchoTREK in programming mode
2) Press any of the DOWN (⬇), ENTER (Ⓜ), NEXT (↶) buttons steadily	●● = – hold last value – 3.6 mA – 22 mA
3) Release buttons	○○ = Programming completed

Damping time setting (Check for a valid echo as above)

Action	Led state following the action
1) Press ENTER (E) button steadily	○○ = EchoTREK in programming mode
2) Press any of the NEXT (N), UP (U), DOWN (D) buttons steadily	○● = - 10 sec ●● = - 30 sec ●● = - 60 sec
3) Release buttons	○○ = Programming completed

RESET: Returning to the default (Check for a valid echo as above)

Action	Led state following the action
1) Press NEXT (N) button steadily	○○ = EchoTREK in programming mode
2) Press ENTER (E) button steadily	●● = Default loaded

Indication of mistakes (by LEDs) made during programming

Action	Led state following the action	Possible correction
Attempted programming	●● = blinking twice = no Echo	Find a valid Echo
Attempted programming	●● = blinking three times = no access possible	With SAP-200 only See 5.2 (P99)
Attempted programming	●● = blinking four times = EchoTREK not in Level Measurement Mode	With SAP-200 only See 5.2 (P01)

5.2 PROGRAMMING WITH THE SAP-200 DISPLAY MODULE

The EchoTREK should be adjusted to the process by programming the parameters. The SAP-200 Display Module can be used to display the parameters during programming and measurement values during measurement.

The SAP-200 supports two separately accessible programming modes representing 2-layers of programming complexity, depending on user choice.

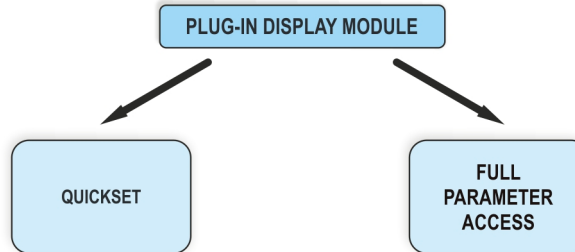

QUICKSET (5.2.4)

Recommended as a simple and fast way to set up the EchoTREK by 6 basic parameters for the following basic settings, marked by abbreviations easy to remember

- Engineering unit for the display (Metric or US)
- Maximum measuring distance (H)
- Assignment of min level to 4 mA
- Assignment of max level to 20 mA
- Error indication by the current output
- Damping time

Full Parameter Access (5.2.5)

All features of the EchoTREK such as:

- Measurement configuration
- Outputs
- Measurement optimization
- 11 pre-programmed tank shapes for volume calculation
- 21 pre-programmed formula for flow metering
- 32-point linearization

Enter into or quit programming modes

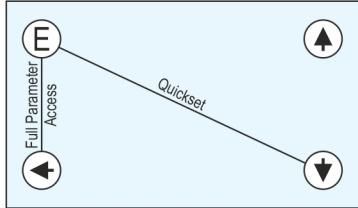

Basic steps while parameter address is blinking

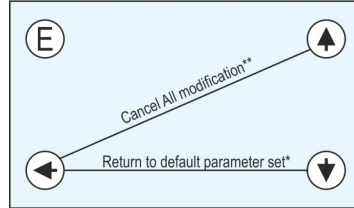

* LOAD readout
** CANCEL readout

Basic steps while parameter value is blinking

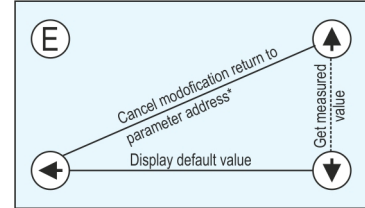

* cancellation immediately active

GET LEVEL function

Special function used only in level and distance measurement modes UP (▲) + DOWN (▼)

Notes:

If after pressing ENTER (E) blinking does not spring over from the parameter address to the parameter value this means that

- the parameter is either a read-out type, or
- the secret code prevents the modification (see P99)

If the modification of the parameter value is not accepted i.e. the parameter value keeps blinking after pressing ENTER (E),

- the modified value is either out of the range, or
- the code entered is not a valid code

5.2.3 Indications of the SAP-200 and LED Status

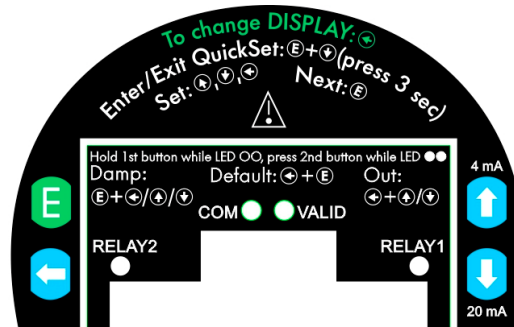

LED indication

- **VALID (ECHO)-LED**
lit in case of valid echo.
- **COM-LED**
see description of HART
- **RELAY-LED**
ON – when the 'C2' circuit of the relay is closed

SAP-200 indications



Depending on the measurement one of the below symbols will lit and the process value displayed (see P01 chapter 6.1). Engineering units will be indicated directly (°C, °F and mA) and by the lit arrow showing towards them on the frame

- DIST distance
- LEVlevel
- VOL volume
- FLOW flow
- T1/T2 totalized values
- FAIL (blinking) Error code displayed

For paging readouts NEXT  key should be pressed.

The following process values can be displayed

- Volume / Flow – if programmed so
- Level – if programmed so
- Distance – if programmed so
- Warning indications – FAIL blinking

Display screens can be scrolled by pressing key NEXT . To return to the screen of the selected measurement mode key ENTER  should be pressed (see P01 chapter 6.1)

Temperature can be displayed by pressing UP .

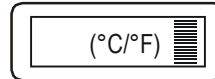

Current output value can be displayed by pressing DOWN .

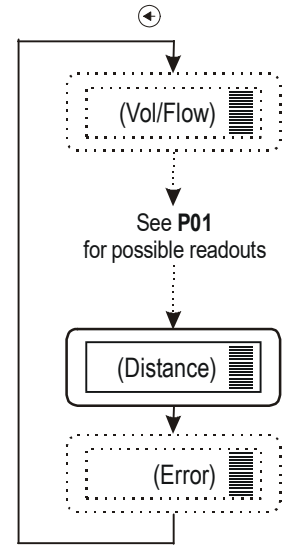
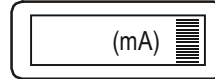

5.2.4 QUICKSET

Recommended as a simple and fast way to start up EchoTREK.

QUICKSET programming (aided by 6 screens) is used in uncomplicated level metering applications to set the 6 basic parameters. The other parameters can only be modified in the Full Parameter Access Mode see 5.1 (P01).

The instructions of this programming mode are also to be found on the front panel above the Display Module socket.

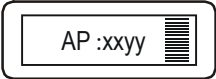
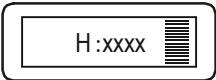
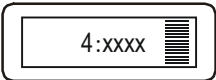

Keys	Function
ENTER (E) + DOWN (D) (press for min 3 secs!)	Enter or exit QUICKSET programming mode
UP (U), DOWN (D), NEXT (N)	Increase/decrease and move left the blinking digit
UP (U) + DOWN (D)	"GET LEVEL" – display actual level measured by the EchoTREK
ENTER (E)	Save readout and step to the next screen
NEXT (N) + UP (U)	Quit Current Output Scaling without saving the modifications (CANCEL))
NEXT (N) + DOWN (D)	Display of the DEFAULT value.

Screens	Actions
	<p>Application xx= select "EU" (European) for metric or "US" for US engineering units (Use UP (U) / DOWN (D) keys) yy= indicating "Li" for liquids DEFAULT: EU</p> <div style="border: 1px solid black; padding: 5px; text-align: center;"> <p>Programming of this parameter will result in loading the factory default with the corresponding engineering units.</p> </div>
	<p>H = xxxx maximum measuring distance – Distance between transducer face and tank bottom Manual: set value (Use UP (U) / DOWN (D) / NEXT (N) keys) and save it (by ENTER (E)) Automatic: use the "GET LEVEL" function (UP (U) + DOWN (D)) to obtain actual measured value with level in tank or a fixed target, i.e. wall. ("GET LEVEL" functions only if ECHO LED is lit) and save it as above. DEFAULT: maximum measuring distance [m], see Technical Data Table</p>
	<p>4 mA xxxx – level value assigned to 4 mA current output Manual: set level value (by UP (U) / DOWN (D) / NEXT (N) keys) and save it (by ENTER (E)) Automatic: use the "GET LEVEL" function (UP (U) + DOWN (D)) to display the actual measured value with level in tank or a fixed target, i.e. wall. ("GET LEVEL" functions only if ECHO LED is lit) and save it as above. DEFAULT: 0 m (0%, Empty tank)</p>

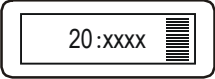
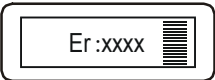
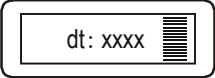
Screens	Actions
	<p>20 mA xxxx – level value assigned to 20 mA current output</p> <p>Manual: set level value (Use UP ▲ / DOWN ▼ / NEXT ◀ keys) and save it (by ENTER ⊞)</p> <p>Automatic: use the “GET LEVEL” function (UP ▲ + DOWN ▼) to obtain actual measured value with level in tank or a fixed target, i.e. wall. (“GET LEVEL” functions only if ECHO LED is lit) and save it as above.</p> <p>DEFAULT: max. level = max. measuring distance – dead band [m] (100%, Full tank) (See Technical Data Table)</p>
	<p>Error indication by the current output – select “Hold”, 3.8 mA or 22 mA (by UP ▲ / DOWN ▼ key) and save it as above.</p> <p>DEFAULT: hold last value</p>
	<p>damping time: select required damping time (by UP ▲ / DOWN ▼ key) and save it as above.</p> <p>DEFAULT: 60 sec for liquids, 300 sec for solids</p>

Note: – Current output can also be programmed for inverted operation: 4 mA= 100% (Full), 20 mA= 0% (Empty)
– Description of failures can be found under the chapter 7 Error codes.

5.2.5 Full Parameter Access

Full Parameter Access is the highest programming level to access all features provided by the EchoTREK

Description of all parameters can be found under the chapter “Parameter” (Chapter 6.).

Keys	Function
ENTER ⊞ + NEXT ◀ (press for 3 seconds)	Enter or exit Full Parameter Access programming mode.

In this programming mode, the display will indicate:

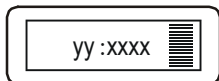

yy Parameter Address (P01, P02 ... P99)
xxx Parameter Value (dcba)
≡ bargraph

Measuring is going on during programming in accordance with the old parameter set. New parameter set will be valid after returning to the Measurement from the Programming Mode.

Steps and indications of the Full Parameter Access programming mode

pressing Keys	while Parameter Address is blinking	while Parameter Value is blinking
ENTER (E)	Go to the Parameter Value	Save the modification of the Parameter Value and return to the Parameter Address
NEXT (←) + UP (↑)	Cancel all modifications of the actual programming phase. Pressing for 3 sec is required while CANCEL will be displayed for warning	Neglect the modification of the Parameter Value. and return to the Parameter Address without saving the modifications
NEXT (←) + DOWN (↓)	Reset entire device to Factory Default. Since this action will reset all parameters, "LOAD" will appear on the display: – to confirm, press – to escape, press any other key – Exception: clearing TOT 1 (See at P77)	Display default of the Parameter Values (it can be saved by pressing ENTER (E))
NEXT (←)	Move blinking (changeability) of the digit to the left	
UP (↑) / DOWN (↓)	Modify the blinking digit (increase, decrease) or scroll up/down	

6. PARAMETERS – DESCRIPTIONS AND PROGRAMMING

6.1 MEASUREMENT CONFIGURATION

P00: - cba Application/Engineering Units

Programming of this parameter will result in loading the factory default with the corresponding engineering units.

a	Operating (measurement) mode
0	Liquid level measurement

b	Engineering units (according to "c")	
	Metric	US
0	m	ft
1	cm	inch

c	Calculation system
0	Metric
1	US

Attention: mind the sequence!
When programming this parameter the right value "a" will be blinking first.

FACTORY DEFAULT: 000

P01: - ba Measurement Mode – Bargraph

Parameter value „a” will determine the basic measurement value that will be displayed and proportional with the current output. Depending on the value of “a” process values as listed in the 3rd column can also be displayed by pressing NEXT (⬅). For return to the display of the basic value the ENTER (Ⓔ) key should be pressed.

a	Measurement Mode	Display symbol	Displayed values
0	Distance	DIST	Distance
1	Level	LEV	Level, Distance
2	Level in percentage	LEV%	Level%, Level, Distance
3	Volume	VOL	Volume, Level, Distance
4	Volume in percentage	VOL%	Volume%, Volume, Level, Distance
5	Flow	FLOW	Flow, TOT1, TOT2, Level, Distance

**Attention: mind the sequence!
When programming this parameter the right value “a” will be blinking first.**

Parameter value “b” will determine that the height of the Bargraph will be proportional to the current output or to the Echo strength.

b	Bargraph indication
0	Echo strength
1	Current output

FACTORY DEFAULT: 11

P02: - cba Calculation units

a	Temperature
0	°C
1	°F

**Attention: mind the sequence!
When programming this parameter the right value “a” will be blinking first.**

This table is interpreted according to P00(c), P01(a) and P02(c) and is irrelevant in case of percentage measurement (P01(a)= 2 or 4)

b	Volume		Weight (set also P32)		Volume flow	
	Metric	US	Metric	US	Metric	US
0	m ³	ft ³	tons	lb (pound)	m ³ /time	ft ³ /time
1	liter	gallons	tons	tons	liter/time	gallons/time

c	Time
0	Sec
1	Min
2	Hour
3	Day

FACTORY DEFAULT: 000

P03: --- a Values displayed - Rounding

It is important to keep in mind that the instrument is measuring distance as basic quantity.

Measured Distance	Resolution
X _{min} ...2 m	1 mm
2...5 m	2 mm
5...10 m	5 mm
10 m over	10 mm

Displayed VOL or FLOW

Displayed Value	Display Format
0,000 – 9,999	x,xxx
10,000 – 99,999	xx,xx
100,000 – 999,999	xxx,x
1000,000 – 9999,999	xxxx,x
10000,000 – 99999,999	xxxxx,x
100000,000 – 999999,999	xxxxxx,x
1 million – 9,99999*10 ⁹	x,xxxx : e (exponential format)
1*10 ¹⁰ over	(overflow) Err4

Rounding

Parameter Value “a”	Steps In The Displayed Value
0	1 (no rounding)
1	2
2	5
3	10
4	20
5	50

FACTORY DEFAULT: 0

The resolution depending on the distance can be considered as a kind of rounding that will be contained in all further value (of level, volume or volume flow) calculated. Therefore, if programmed for DIST or LEV measurement the setting of P03 is irrelevant.

Obviously the decimal position will be shifted with increasing value displayed. (See table at the left).

Values over one million will be displayed in exponential format whereas the value (e) represents the exponent. Over the value of 1x10¹⁰ Err4 (overflow) will be displayed.

A couple of millimetres of fluctuation of the basic DIST value (e.g. due to waves) will be enlarged by the mathematical operations. This enlarged fluctuation in displaying VOL or FLOW can (if disturbing) be avoided by rounding to be set in P03. Rounding value 2, 5, 10 etc. represents the steps by which the calculated value will be changed in its (one or two) last digit(s).

Examples:

P03=1 steps by 2: 1,000; 1,002; 1,004

P03=5 steps by 50: 1,000; 1,050; 1,100 or 10,00; 10,05(0); 10,10(0); 10,15(0)
(the 0 from the steps 50, 100, 150 etc will not be displayed)

P04 Maximum Distance to be Measured (H)

The maximum distance to be measured is the greatest distance between the surface of the transducer and the level to be measured.

This is the only parameter that has to be programmed for each application other than distance (however to avoid disturbing effect of possible multiple echos it is suggested to do this in distance measurement applications too).

Values of the maximum measuring distance will be displayed as below.

Engineering Unit	Display Format
m	x,xxx Or xx,xx
cm	xxx,x
ft	xx,xx Or xxx,x
inch	xxx,x

The factory programmed, greatest distances (DEFAULT values) which **can be measured** by the units are listed in the table below. For the actual application the maximum distance **to be measured** i.e. the distance between the sensor and the bottom of the tank should be entered in P04.

To obtain the best accuracy, measure this distance in the empty tank with the EchoTREK by using the "GET LEVEL" function (by double key pressing of UP ⬆ + DOWN ⬇) provided the bottom is flat. Enter the actual measured value displayed as P04.

EchoTREK	Maximum measuring distance [m/ft]		
	Transducer material PP / PVDF	Transducer material PTFE	Transducer material Stainless steel
S-49	4/13	3/10	-
S-48	6/20	5/16	-
S-47	8/26	6/20	-
S-46	10/33	-	7/23
S-44	15/49	-	12/39
S-42	25/82	-	15/49

FACTORY DEFAULT: according to the table

P05: Minimum measuring distance (Dead zone- Close-end blocking)

The EchoTREK will not accept any echo within the blocking distance set here.

Automatic Close-end-blocking (Automatic Dead Band control)

By using the factory default value, the unit will automatically set the smallest possible close-end-blocking distance i.e. the dead band.

Manual close-end-blocking

Manual close-end-blocking should be used for example to block out the echo originating from the bottom rim of a stand-off pipe or from any object protruding into the ultrasonic cone near to the transmitter.

By entering a value, higher than the factory default, the minimum measuring range will be extended and fixed to the specified value.

To return to the factory programmed (DEFAULT value) of the minimum measuring distance press NEXT (◀) + DOWN (▼).

EchoTREK	Minimum measuring distance X_M [m/ft]		
	Sensor material PP / PVDF	Sensor material PTFE	Sensor material Stainless steel
S-49	0.2 / 0.65	0.2 / 0.65	-
S-48	0.25 / 0.82	0.25 / 0.82	-
S-47	0.35 / 1.20	0.35 / 1.20	-
S-46	0.35 / 1.20	-	0.4 / 1.30
S-44	0.45 / 1.50	-	0.55 / 1.80
S-42	0.6 / 2.00	-	0.65 / 2.2

FACTORY DEFAULT: automatic dead band control

P06: Far end blocking

Far end blocking is used to neglect incorrect level/volume readings and output actions below a pre-set level programmed in P06.

A). Level measurement

The far-end blocking can be used to avoid disturbing effect of stirrer or heaters at the bottom of the tanks.

If the level of the medium sinks below the blocked out range:

- "Sub 0" will be indicated for the level and volume
- Distance value is not interpretable
- Current output will hold the value corresponding to the far end blocking level

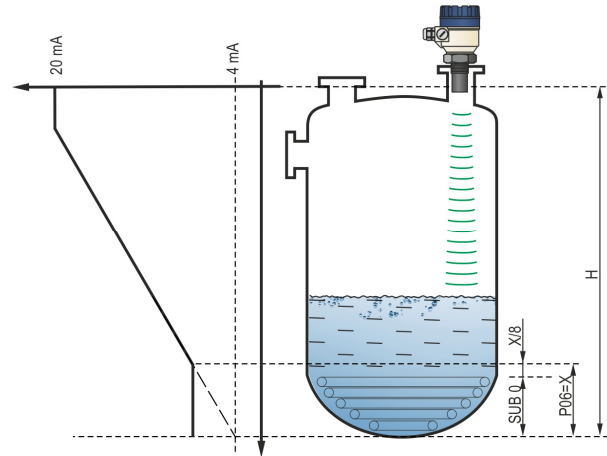

If the medium level is above the blocked out range:

The calculation of level and volume will be based on the programmed tank dimensions, therefore the measured or calculated process values will not be influenced in any way, by the far end blocking value.

B). Open channel flow metering

Far end blocking will be used for those small levels below which the accurate volume flow calculation is no longer possible.

If the liquid level in the flume/weir falls below the blocked out range:

The EchoTREK will act as follows:

- Indicate "No Flow" on the Display
- Hold last valid data on the current output.

If the level in the flume/weir is above the blocked out range:

The calculation of volume flow will be based on the programmed flume/weir data; therefore the measurement values will not be influenced in any way, by the far end blocking value.

FACTORY DEFAULT: 0

6.2 CURRENT OUTPUT

P10: Value (of distance, level, volume or flow) assigned to 4 mA current output

P11: Value (of distance, level, volume or flow) assigned to 20 mA current output

Values are interpreted according to **P01(a)**. Please note that in case of programming for (LEV or VOL) % measurement the min and max value has to be entered in the relevant engineering units of LEV (m, ft) or VOL (m³, ft³).

Assignment can be made so that the proportion between the change of the (measured or calculated) process value and the change of the current output be either direct or inverse. E.g. lev 1 m assigned to 4mA and lev 10 m assigned to 20 mA represents direct proportion and lev 1 m assigned to 20 mA and lev 10 m assigned to 4 mA represents the inverse proportion.

FACTORY DEFAULT:

P10 0 level (max distance)

P11 max level (min distance) H

P12: - - - a Error indication by the current output

In case of error the EchoTREK will provide one of the current outputs below. (For errors and their interpretation see Chapter 7).

a	ERROR INDICATION (ACCORDING TO NAMUR)
0	Hold last value
1	3.8 mA
2	22 mA

FACTORY DEFAULT: 0

6.3 RELAY OUTPUT

P13: --- a Relay function

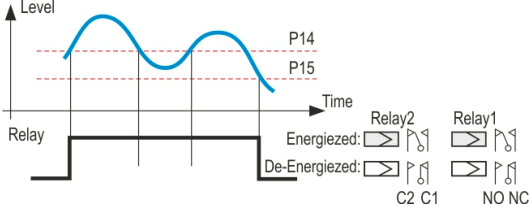
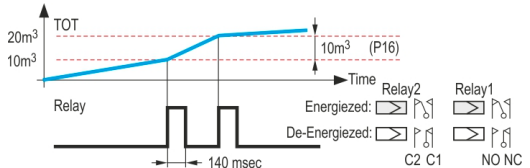
a	Relay function	Also set	
0	<p>DIFFERENTIAL LEVEL CONTROL (Hysteresis control)</p> <p>Relay is energized if the measured or calculated value exceeds the value set in P14 Relay is de-energized if the measured or calculated value descends under the value set in P15.</p>		<p>P14, P15</p> <p>There is a need to set (in level min. 20 mm) hysteresis between P14 and P15</p> <p>P14 > P15 – normal operation P14 < P15 – inverted operation</p>
1	Relay is energized in case of Echo Loss	-	
2	Relay is de-energized in case of Echo Loss	-	
3	<p>COUNTER</p> <p>Used for open channel flow metering.</p> <p>A 140 msec pulse is generated every 1, 10, 100, 1.000 or 10.000 m³ according to P16.</p>		<p>P16 = 0: 1m³ P16 = 1: 10 m³ P16 = 2: 100 m³ P16 = 3: 1.000 m³ P16 = 4: 10.000 m³</p>

In de-energized state of the device the 'C1' circuit is closed.

The 'Relay' LED is on when the 'C2' circuit is closed.

FACTORY DEFAULT: **P13=2**

P14: ---- Relay parameter – Operating value

P15: ---- Relay parameter – Releasing value

P16: ---- Relay parameter – Pulse rate P13(3)

FACTORY DEFAULT: **P14=0, P15=0, P16=0**

6.4 MEASUREMENT OPTIMISATION

P20: --- a Damping

This parameter can be used to reduce unwanted fluctuation of the display and output.

a	Damping time (seconds)	LIQUIDS	
		None/moderate fume or waves	Heavy/dense fume or turbulent waves
0		no filter	
1	3	applicable	not recommended
2	6	recommended	applicable
3	10	recommended	recommended
4	30	recommended	recommended
5	60	recommended	recommended

FACTORY DEFAULT: 60 sec

P22: --- a Dome top tank compensation

This parameter can be used to reduce disturbing effect of possible multiple echos.

a	Compensation	Applied
0	OFF	In case the EchoTREK is not mounted in the center of the top and the top is flat.
1	ON	In case the EchoTREK is mounted in the center of a tank with dome-shaped top

FACTORY DEFAULT: 0

P24: --- a Target tracking speed

In this parameter evaluation can be speed up at the expense of the accuracy.

a	Tracking speed	Remark
0	Standard	For most applications
1	Fast	For fast changing level
2	Special	Only for special applications (measuring range is reduced to 50% of the nominal value) The measuring window is inactive and the EchoTREK will respond practically instantly to any target. Recommended to fast target tracking, but usually not applicable for level metering.

FACTORY DEFAULT: 0

P25: - - - a Selection of Echo within the measuring window

A so-called measuring window is formed around the echo signal. The position of this measuring window determines the flight time for calculation of the distance to the target. (the picture below can be seen on the test oscilloscope)

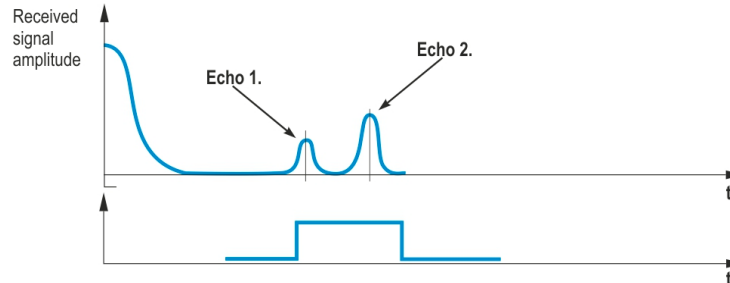

Some applications involve multiple (target + disturbing) echoes even within the measuring window. Basic echo selection will be done by the Quest + software automatically. This parameter only influences the echo selection within the measuring window.

a	Echo in the window to be selected	Remark
0	With the highest amplitude	For most applications (both with liquids and solids)
1	First one	For liquids applications with multiple echoes within the Measuring Window

FACTORY DEFAULT: 0

P26: Level elevation rate (filling speed) (m/h)

P27: Level descent rate (emptying speed) (m/h)

These parameters provide additional protection against echo loss in applications involving very heavy fuming.

The parameters must not be smaller than the fastest possible filling/emptying rate of the actual technology.

For all other applications, use the factory default setting.

FACTORY DEFAULT:

2000 for both **P26** and **P27**

P28: --- a Echo loss indication

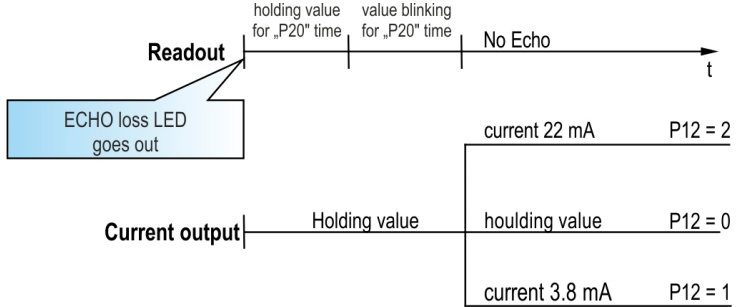
a	Echo loss indication	Remark
0	Delayed indication	<p>During echo-loss, display and analogue output will hold last value. If the echo-loss prevails for 10 sec plus the time period set in P20 (damping time), the reading on the display will change to 'no Echo' and the outputs will change according to the 'Error Indication Mode' pre-set in P12</p> 
1	No indication	For the time of echo-loss, display and analogue output will hold last value.
2	Advance to full	During echo-loss in case of filling, the reading on the display and analogue output will shift towards the "full" tank state with a level elevation rate (filling speed) pre-set in P26
3	Immediate indication	In case of echo-loss, the display will immediately change to 'no Echo', and the outputs will change according to the 'Error Indication Mode' pre-set in P12
4	Empty tank indication	Echo-loss may occur in completely empty tanks with a spherical bottom due to deflection of the ultrasonic beam, or in case of silos with an open outlet. If the echo is lost when the tank is completely empty, the indication will correspond to empty tank, in all other cases echo-loss indication will function according to the "Delayed".

FACTORY VALUE: 0

P29: Blocking out of disturbing object

One fixed object in the tank, disturbing the measurement, can be blocked out.

Enter distance of the object from the transducer. Use the Echo Map (P70) to read out the precise distance of disturbing objects.

FACTORY DEFAULT: 0

P31: Sound velocity at 20 °C (m/sec or ft/sec depending on P00(c))

Use this parameter if the sound velocity in the gases above the measured surface differs largely from that of in air.

Recommended for applications where the gas is more or less homogeneous. If it is not, the accuracy of the measurement can be improved using 32-point linearization (P48, P49).

For sound velocities in various gases see section 'Sound Velocities'.

FACTORY DEFAULT: Metric (P00: 'EU'): 343.8 m/s, US (P00: 'US'): 1128 ft/s

P32: Specific gravity

If you enter a value (other than '0') of specific gravity in this parameter, the weight will be displayed instead of VOL.

FACTORY DEFAULT: 0 [kg/dm³] or [lb/ft³] depending on P00 (c)

6.5 DATA LOGGER

The logger of the device can store 12288 events. The registry is in a non-volatile (FLASH) memory, so the registry will retain its contents even in case of a power failure. The on-board clock of the device is protected against short power-outs, and keeps working for at least 15 days after the device is switched off. The battery protecting the clock needs at least two hours to be recharged.

The logger operates in two basic ways.

Linear logging, whereby an entry is logged after every time period configured in P35.

Event-controlled logging, whereby an entry is logged after an internal event occurs or condition is fulfilled.

The capacity of the registry allows the following logging times in linear logging mode:

P35 [min]	Time of logging	Note
0	3...5 hours	depends on device type and measurement cycle time
1	7...8 days	
5	40 days	
10	80 days	
60	500 days (16 months)	

Content of a log:

- entry time (with an accuracy of 1 minute)
- primary measured value (P01)
- level and distance values
- sensor temperature
- output current
- error and status variables

The registry can be erased in parameter P79. See: P79.

P34: - cba Logging mode

a	Operating mode	Parameters to be programmed
0	No logging	
1	Linear logging	P35 – interval (minute)
2	Event-controlled logging when the primary value changes	P35 – absolute value of variation
3	Event-controlled logging when primary value changes	P35 – variation in %
4	Event-controlled logging when the primary value gets out of range	P35, P36 – absolute values of range limits

b	Logging of errors and warnings (a>0)
0	No logging
1	Logging of all errors and warnings
2	Logging of errors only
3	Logging of NoEcho only

c	Logging of changes in status (a>0)
0	No logging
1	Logging of change in status

FACTORY SETTING: 000 (no logging)

Errors that may generate an entry if P34/b<>0: NOECHO, ERR 16, ERR12, ERR13, ERR14, ERR15, SUB0, ERR4, ERR5, PT ERR (temperature measurement error).

P35-36: Log value 1 and log value 2

P34a	Operating mode	Function of P35 and P36
0	No logging	
1	Linear logging	<p>P35 = 0 One entry after every measurement cycle. P35 <> 0 Logging interval (minutes) P36 Value is indifferent</p>
2	Event-controlled logging when the primary value changes	<p>P35 Absolute value of the change in the primary measured value (according to P01a) P35 is defined as the dimension of the primary measured unit. Log entry occurs if the value of the primary measured value deviates from the measured value of the previous cycle in any direction by the amount specified in P35. P36 Value is indifferent</p>
3	Event-controlled logging when the primary value changes	<p>P35 Relative (%) value of primary measured value (according to P01a) variation. P35 is a relative quantity so its dimension is percent. Log entry occurs if the value of the primary measured value deviates from the measured value of the previous cycle in any direction by the amount specified in P35. P36 Value is indifferent</p>
4	Event-controlled logging when the primary value gets out of range in any direction	<p>P35, P36 Absolute values of the limits of the range of the primary measured values (according to P01a). P35 and P36 have the same dimension as the primary measured value. Log entry occurs if the value of the primary measured value steps over the limit given in P35 and P36, in any direction. To monitor only one limit value, set it in P35 and let P36 be 0.</p>

FACTORY SETTING: P35 = 0, P36 = 0

P37: yyyy Real-time clock, year

Year setting for date of the on-board clock. (e.g.: 2005)

P38: mmdd Real-time clock, month and day

Month (mm) and day (dd) setting for date of the on-board clock.

P39: HHMM Real-time hour and minute

Hour (HH) and minute (MM) setting of the on-board clock.

6.5.1 READING DATA OUT FROM THE LOGGER

The content of the log cannot be displayed with an SAP-200. Reading the logger is only possible with digital communication. For this purpose either the SAP-200's built-in IrDA port or an ELink (USB) communication adapter plugged into the SAP-200 slot can be used. The content of the log can also be read out via HART communication, but because of the slow speed of HART, it takes several hours. To access the data content the use of NIVELCO's DataScope program is recommended. During the high-speed communication with ELink or SAP-200 the device sets the output current to 22 mA. There is no measurement while retrieving data from the register, so measurement values are not updated.

Connecting to a PC using an IrDA adapter:



The IrDA adapter and the IrDA port of the device must be placed within a 5...50 cm distance and facing each other!

- RedSnake: IL-200
- ActiSys: ACT-IR200S
- ACT-IR220L+
- ACT-IR220LR
- M8421
- Esis:

Recommended IrDA adapters:

(only IrDA to RS232 adapters can be used)*

* Recommended RS232-USB adapters for using the USB port: STLab: USB-RS232
MOXA: NPort-U1110, UPort 1110

After connecting the adapters start DataScope program.

6.6 VOLUME MEASUREMENT

P40: -- ba Tank shape

ba	Tank shape	Also to be set
b0	Standing cylindrical tank shape (value of 'b' as below)	P40 (b), P41
01	Standing cylindrical tank with conical bottom	P41, P43, P44
02	Standing rectangular tank (with chute)	P41, P42, (P43, P44, P45)
b3	Lying cylindrical tank shape (value of 'b' as below)	P40 (b), P41, P42
04	Spherical tank	P41

Attention!
The value 'a' determining the shape of the tank should be set first.

FACTORY DEFAULT: 00

P41-45: Tank dimensions

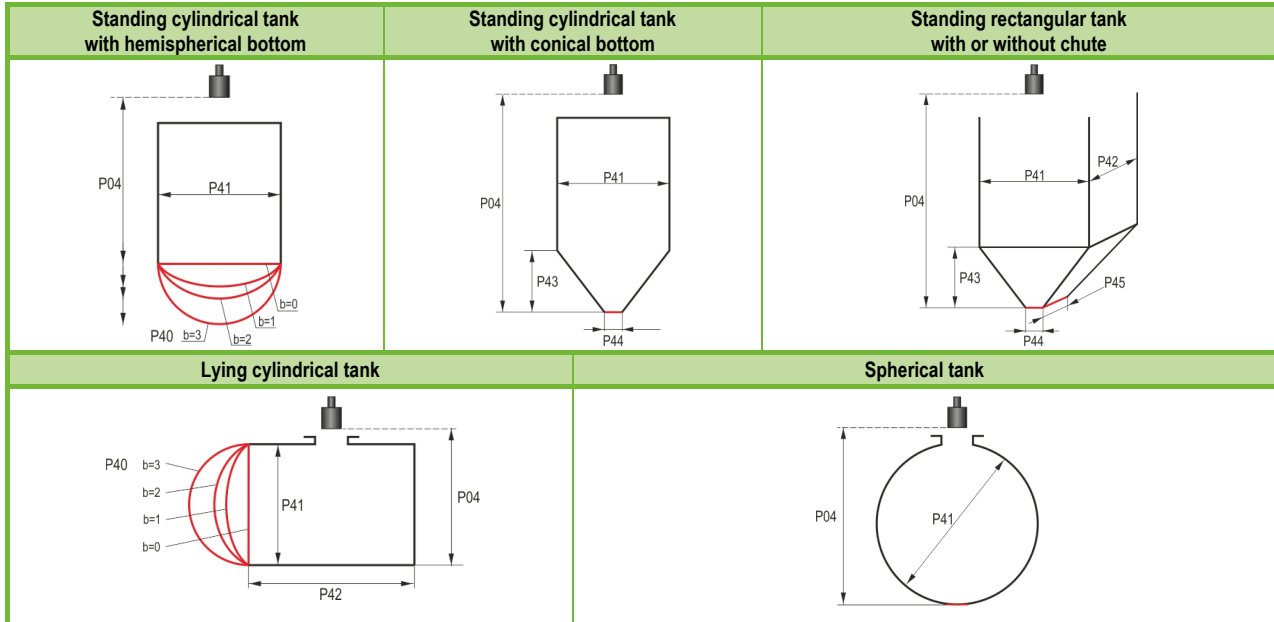

6.7 VOLUME FLOW MEASURING

P40: -- ba Devices, formula, data

ba	Devices, formula, data					Also to be set	
	Type	Calculation formula	Qmin [l/s]	Qmax [l/s]	"P" [cm]		
00	NIVELCO Parshall flume	GPA-1P1	$Q[l/s] = 60.87 * h^{1.552}$	0.26	5.38	30	P46
01		GPA-1P2	$Q[l/s] = 119.7 * h^{1.553}$	0.52	13.3	34	P46
02		GPA-1P3	$Q[l/s] = 178.4 * h^{1.555}$	0.78	49	39	P46
03		GPA-1P4	$Q[l/s] = 353.9 * h^{1.558}$	1.52	164	53	P46
04		GPA-1P5	$Q[l/s] = 521.4 * h^{1.558}$	2.25	360	75	P46
05		GPA-1P6	$Q[l/s] = 674.6 * h^{1.556}$	2.91	570	120	P46
06		GPA-1P7	$Q[l/s] = 1014.9 * h^{1.556}$	4.4	890	130	P46
07		GPA-1P8	$Q[l/s] = 1368 * h^{1.5638}$	5.8	1208	135	P46
08		GPA-1P9	$Q[l/s] = 2080.5 * h^{1.5689}$	8.7	1850	150	P46
09	General Parshall flume					P46, P42	
10	PALMER-BOWLUS (D/2)					P46, P41	
11	PALMER-BOWLUS (D/3)					P46, P41	
12	PALMER-BOWLUS (Rectangular)					P46, P41, P42	
13	Khafagi Venturi					P46, P42	
14	Bottom-step weir					P46, P42	
15	Suppressed rectangular or BAZIN weir					P46, P41, P42	
16	Trapezoidal weir					P46, P41, P42	
17	Special trapezoidal (4:1) weir					P46, P42	
18	V-notch weir					P46, P42	
19	THOMSON (90°-notch) weir					P46	
20	Circular weir					P46, P41	
21	General flow formula: $Q[l/s] = 1000 * P41 * h^{P42}$, h [m]					P46, P41, P42	

FACTORY DEFAULT: 0

P41-45: Flume/weir dimensions

FACTORY DEFAULT: 0

P40= 00

NIVELCO Parshall flumes (GPA1P1 ... GPA-1P9)

For further details see the Manual of the Parshall flume

·
·
·
·

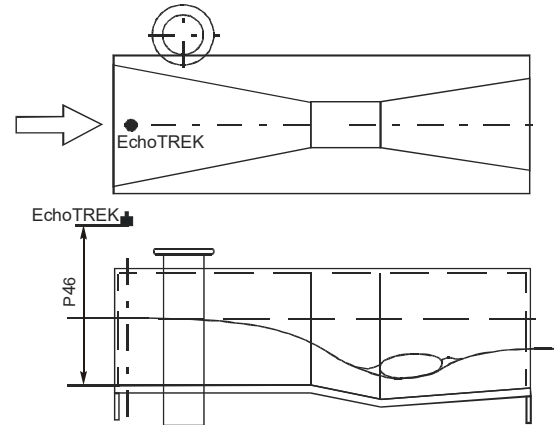

P40= 09

General Parshall flume

$0.305 < P42(\text{width}) < 2.44$

$$Q[\text{m}^3/\text{s}] = 372 \cdot P42 \cdot (h/0.305)^{1.569} P42^{0.026}$$

$2.5 < P42$

$$Q[\text{m}^3/\text{s}] = K \cdot P42 \cdot h^{1.6}$$

$P = 2/3 \cdot A$

P42[m]	K
3.05	2.450
4.57	2.400
6.10	2.370
7.62	2.350
9.14	2.340
15.24	2.320

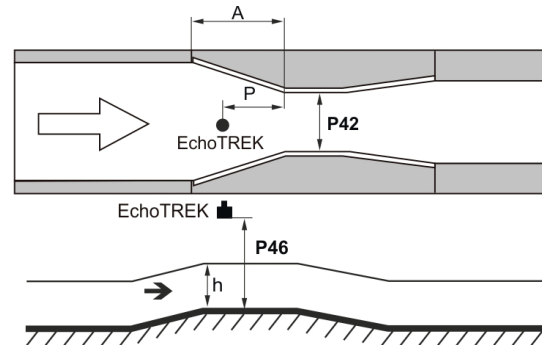

<p>P40= 10</p>	<p>Palmer-Bowlus (D/2) flume</p> <p>$Q[m^3/s]= f(h1/P41)*P41^{2.5}$, where $h1[m]= h+(P41/10)$</p>	
<p>P40= 11</p>	<p>Palmer-Bowlus (D/3) flume</p> <p>$Q[m^3/s]= f(h1/P41)*P41^{2.5}$, where $h1[m]= h+(P41/10)$</p>	
<p>P40= 12</p>	<p>Palmer-Bowlus (Rectangular) flume</p> <p>$Q[m^3/s]= C*P42*h^{1.5}$, where $C= f(P41/P42)$</p>	

P40= 13

Khafagi Venturi flume

$$Q[m^3/s] = P42 * 1.744 * h^{1.5} + 0.091 * h^{2.5}$$

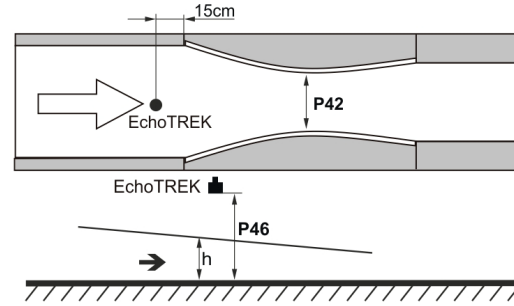

P40= 14

Bottom step weir

$$0.0005 < Q[m^3/s] < 1$$

$$0.3 < P42[m] < 15$$

$$0.1 < h[m] < 10$$

$$Q[m^3/s] = 5.073 * P42 * h^{1.5}$$

Accuracy: $\pm 10\%$

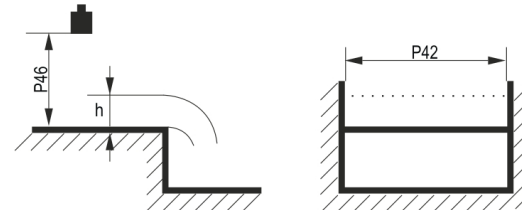

P40= 15

Suppressed rectangular or BAZIN weir

$$0.001 < Q[m^3/s] < 5$$

$$0.15 < P41[m] < 0.8$$

$$0.15 < P42[m] < 3$$

$$0.015 < h[m] < 0.8$$

$$Q[m^3/s] = 1.7599 * [1 + (0.1534/P41)] * P42 * (h + 0.001)^{1.5}$$

Accuracy: $\pm 1\%$

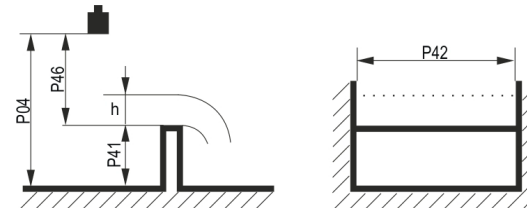

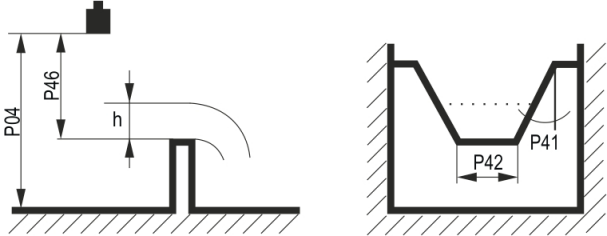
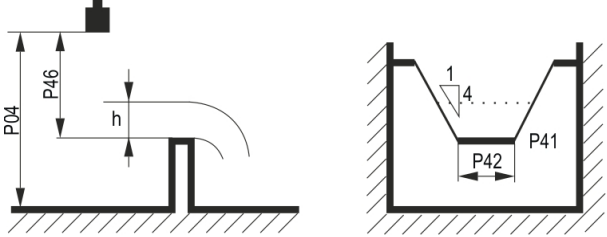
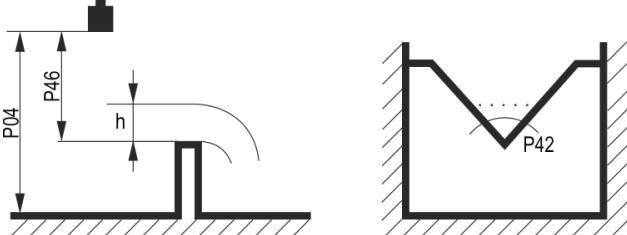
<p>P40= 16</p>	<p>Trapezoidal weir $0.0032 < Q[m^3/s] < 82$ $20 < P41[°] < 100$ $0.5 < P42[m] < 15$ $0.1 < h[m] < 2$ $Q[m^3/s] = 1.772 * P42 * h^{1.5} + 1.320 * tg(P41/2) * h^{2.47}$ Accuracy: $\pm 5\%$</p>	
<p>P40= 17</p>	<p>Special Trapezoidal (4:1) weir $0.0018 < Q[m^3/s] < 50$ $0.3 < P42[m] < 10$ $0.1 < h[m] < 2$ $Q[m^3/s] = 1.866 * P42 * h^{1.5}$ Accuracy: $\pm 3\%$</p>	
<p>P40= 18</p>	<p>V-notch weir $0.0002 < Q[m^3/s] < 1$ $20 < P42[°] < 100$ $0.05 < h[m] < 1$ $Q[m^3/s] = 1.320 * tg(P42/2) * h^{2.47}$ Accuracy: $\pm 3\%$</p>	

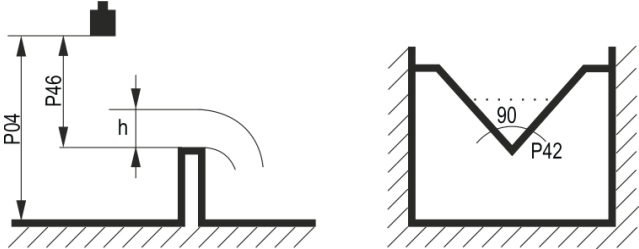
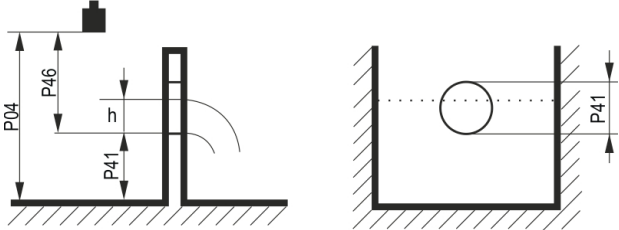
<p>P40= 19</p>	<p>THOMSON (90°-notch) weir</p> <p>$0.0002 < Q[\text{m}^3/\text{s}] < 1$</p> <p>$0.05 < h[\text{m}] < 1$</p> <p>$Q[\text{m}^3/\text{s}] = 1.320 \cdot h^{2.47}$</p> <p>Accuracy: $\pm 3\%$</p>	
<p>P40= 20</p>	<p>Circular weir</p> <p>$0.0003 < Q[\text{m}^3/\text{s}] < 25$</p> <p>$0.02 < h[\text{m}] < 2$</p> <p>$Q[\text{m}^3/\text{s}] = m \cdot b \cdot D^{2.5}$, where $b = f(h/D)$</p> <p>$m = 0.555 + 0.041 \cdot h/P41 + (P41/(0.11 \cdot h))$</p> <p>Accuracy: $\pm 5\%$</p>	

P46: Distance between transducer face and level of Q = 0

P46 is *always* the distance between the transducer face and the level, where the volume flow is 0.

FACTORY DEFAULT: 0

6.8 32-POINT LINEARIZATION

P47: --- a Linearization

Linearization is the method of assigning requested (calibrated or calculated) level, volume or flow to values measured by the transmitter.

It can be used for instance if the sound velocity is not known (LEVEL⇒LEVEL) or in the case of tank with other shape than under 6.4 or open channel other than under 6.5 (LEVEL ⇒ VOLUME or LEVEL ⇒ FLOW).

a	Linearization
0	OFF (FACTORY DEFAULT)
1	ON

P48: Linearization table

Data-pairs of the linearization table are handled in a 2x32 matrix, consisting of two columns.

Left column "L"	Right column "r"
LEVEL measured	LEVEL or VOLUME or FLOW to be transmitted and displayed

The left column values (indicated on the display as "L") contain the measured LEVEL values.

The right column values (indicated on the display as "r") contain the calibrated values and are interpreted according to the selected measurement value in **P01(a)**.

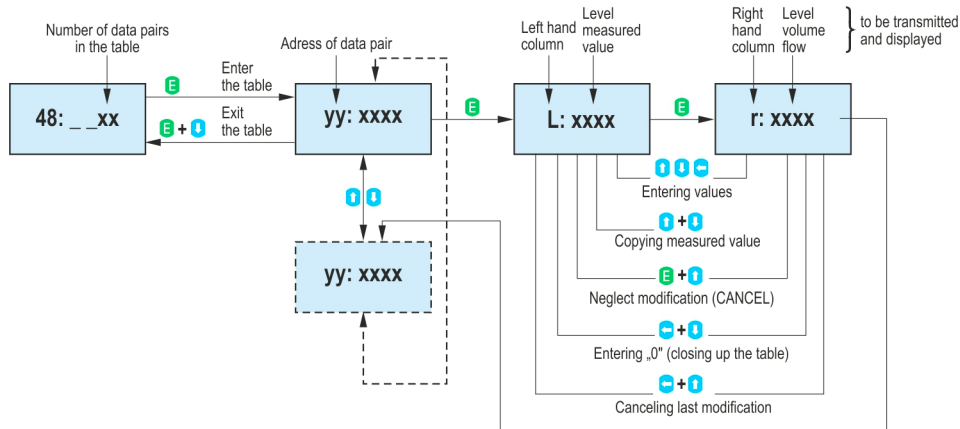

Conditions of correct programming of the data pairs

s	Right column "r"
L(1)= 0	r(1)
L(i)	r(i)
:	:
L(j)	r(j)

The table must always start with: L(1)= 0 and r(1)= value (assigned to 0 level)

The table must be ended either with the 32nd data pair i.e. j=32 or if the linearization table contains less than 32 data-pairs $j < 32$, the table must be closed by a level value "0" e.g. L(j<32)= 0.

The EchoTREK will ignore data after recognizing level value '0' with serial number other than '1'.

If the above conditions are not met, error codes will be displayed (see chapter: Error Codes).

6.9 INFORMATIONAL PARAMETERS (READ OUT PARAMETERS)

P60: Overall operating hours of the unit (h)

Indication varies according to the elapsed time:

Operating hours	Indication form
0 to 999.9h	xxx,x
1000 to 9999h	xxxx
Over 9999h	X,xx: e meaning x,xx 10 ^e

P61: Time elapsed after last switch-on (h)

P62: Operating hours of the relay (h)

P63: Number of switching cycles of the relay (h)

Indications are the same as in P60.

P64: Actual temperature of the transducer (°C / °F)

P65: Maximum temperature of the transducer (°C / °F)

P66: Minimum temperature of the transducer (°C / °F)

In case of a breaking in the temperature measuring Pt10 element „PtErr" will be displayed (See Chapter 7). The transmitter will perform temperature correction corresponding to 20 °C.

P70: Number of Echoes / Echo Map

EchoTREK is monitoring the echo conditions.

Entering this parameter will save the actual echo map.

Number, distance and amplitude of these echoes can be read-out one by one.

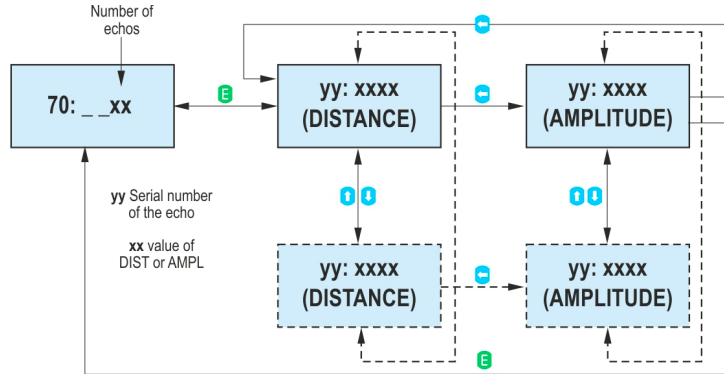

P71: Distance of the of Measuring Window

P72: Amplitude of the Echo in the Measuring

P73: Echo Position (time) :(ms)

P74: Signal To Noise Ratio

Ratio	Measurement conditions
Over 70	Excellent
Between 70 and 30	Good
Under 30	Unreliable

P75: Blocking Distance

The actual close-end blocking distance will be displayed (provided automatic blocking was selected in P05).

6.10 ADDITIONAL PARAMETERS OF THE FLOW METERING

P76: Head of flow (LEV)

The Headwater value can be checked here. This is the “h” value in the formula for flow calculation.

P77: TOT1 volume flow totalizer (resettable)

P78: TOT2 volume flow totalizer (non-resettable)

Resetting TOT1 totalizer:

- 1). Go to the parameter **P77**.
- 2). Press NEXT (←) + DOWN (↓) simultaneously.
- 3). Display will indicate: “t1 Clr”.
- 4.) Press ENTER (↵) to delete.

6.11 SUPPLEMENTARY PARAMETER OF THE LOGGER

P79: Free space of logger in percent

If the value is 0, the registry has overflowed and every new entry will overwrite the oldest one.

Clearing the logger

- 1). Enter parameter **P79**.
- 2). Press (←) + (↓) keys.
- 3). The display flashes „Lo-Clr” message.
- 4). Pressing (↵) will clear the logger.

6.12 TEST PARAMETERS

P80: Current output test (mA)

Going to this parameter, the actual current output (corresponding to the measured process value) will be displayed. By pressing ENTER (⏏) the (now blinking) current value can be set for any value between 3.9 and 20.5 mA. The current output has to show the same value which can be checked by an ampere meter, according to the description under 4.4. Press ENTER (⏏) to quit test mode and return the parameter address

P81: - - - a Relay test

The actual state of the relay can be seen on the display (code according to the table below and symbol on the screen). Test the relay by pressing UP (⬆) and DOWN (⬇) while observing change of the symbol and the code or listening to the ticking of the relay or checking on-off resistance by a suitable resistance meter.

a	Relay state
0	De-energized
1	Energized

P97: b:a.aa Software code

a.aa: Number of the software version

b: Code of the special version

6.13 SIMULATION

This function enables the user to test the settings of the outputs. The EchoTREK can simulate the static or continuous change of level according to the simulation cycle time, high level and low level set in P85, P86 and P87. (The simulation levels must be within the programmed measuring range set in P04 and P05.)

After selecting simulation type in P85 and setting simulation values Measurement Mode has to be re-entered. While the EchoTREK is in simulation mode the DIST, LEV or VOL symbol will be blinking. To quit Simulation Mode **P84 = 0** should be set.

P84: --- x Selection of the simulation

X	Simulation type
0	No simulation
1	The level changes continuously up and down between the level values set in P86 and P87 with a cycle time set in P85

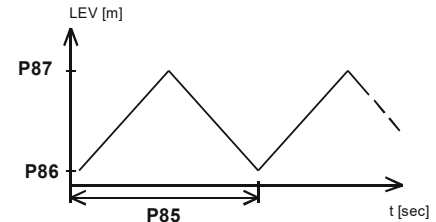

P85: Cycle time for simulation (sec)

P86: Simulated low level value (m)

P87: Simulated high level value (m)

6.14 ACCESS LOCK

P99: dcba Access Lock by Secret Code

The purpose of this feature is to provide protection against accidental (or intentional) re-programming of parameters.

The Secret Code can be any value other than **0000**. Setting a Secret Code will automatically be activated when the EchoTREK is returned to the Measurement Mode. If the Secret Code is activated, the parameters can only be viewed, this is indicated by the a flashing colon ":" between the parameter address and the parameter value.

In order to program the device locked by a secret code, first enter the Secret Code in P99. The Secret Code is re-activated each time the EchoTREK is returned to Measurement Mode.

To delete the Secret Code, enter the Secret Code in P99. After confirming it with [E] re-enter the parameter P99 and enter **0000**.

[dcba (Secret Code)] → [E] → [E] → [0000] → [E] ⇒ **Secret Code deleted**

7. ERROR CODES

Error Code	Error description	Causes and solutions
1	Memory error	Contact local agent
No Echo	Echo loss	No echo received (no reflection) See Action 5 and 6
3	Hardware error	Contact local agent
4	Display overflow	Check settings
5	Sensor error or improper installation/mounting, level in the dead band	Verify sensor for correct operation and check for correct mounting according to the User's Manual
6	The measurement is at the reliability threshold	Better location should be tried.
7	No signal received within the measuring range specified in P04 and P05	Review programming, also look for installation mistake
12	Linearization table error: both L(1) and L(2) are zero (no valid data-pairs)	See the Section "Linearization"
13	Linearization table error: there are two same L(i) data in the table	
14	Linearization table error: the r(i) values are not monotone increasing	
15	Linearization table error: measured Level is higher than the last Volume or Flow data-pair	
16	The check sum of the program in the EEPROM is wrong	Contact local agent
17	Parameter consistency failure	Check programming
18	Hardware failure	Contact local agent

8. PARAMETER TABLE

Par.	Page	Description	Value				Par.	Page	Description	Value			
			d	c	b	a				d	c	b	a
P00	27	Application/Engineering Units					P28	37	Echo loss indication				
P01	28	Measurement Mode					P29	38	Blocking out of disturbing object				
P02	28	Calculation units					P30		N.A.				
P03	29	Rounding					P31	38	Sound velocity in different gases				
P04	30	Maximum Measuring Distance					P32	38	Specific gravity				
P05	31	Minimum Measuring Distance					P33		N.A.				
P06	32	Far End Blocking					P34	38	Logging mode				
P07		N.A.					P35	39	Log value 1 and log value 2				
P08		N.A.					P36	39	Log value 1 and log value 2				
P09		N.A.					P37	40	Real-time clock, year				
P10	33	Value assigned to „4 mA”					P38	40	Real-time clock, month and day				
P11	33	Value assigned to „20 mA”					P39	40	Real-time clock hour and minute				
P12	33	“Error” indication by the current output					P40	44	Selection of tank shape/ open channel				
P13	34	Relay function					P41	43	Dimensions of tank / Open Channel				
P14	34	Relay parameter – Operating value					P42	43	Dimensions of tank / Open Channel				
P15	34	Relay parameter – Releasing value					P43	43	Dimensions of tank / Open Channel				
P16	34	Relay parameter – Pulse rate					P44	43	Dimensions of tank / Open Channel				
P17		N.A.					P45	43	Dimensions of tank / Open Channel				
P18		N.A.					P46	49	Dist. Btw. Transducer face and level of Q=0				
P19		N.A.					P47	50	Linearization				
P20	35	Damping					P48	50	Linearization table				
P21		N.A.					P49		N.A.				
P22	35	Dome top tank compensation					P50		N.A.				
P23		N.A.					P51		N.A.				
P24	35	Target tracking speed					P52		N.A.				
P25	36	Selection of Echo in the measuring window					P53		N.A.				
P26	36	Level elevation rate					P54		N.A.				
P27	36	Level descent rate					P55		N.A.				

Par.	Page	Description	Value	Par.	Page	Description	Value
P56		N.A.		P78	53	TOT2 volume flow totalizer	
P57		N.A.		P79		N.A.	
P58		N.A.		P80	54	Current generator test	
P59		N.A.		P81	54	Relay test	
P60	51	Overall operating hours of the unit		P82		N.A.	
P61	51	Time elapsed after last switch-on		P83		N.A.	
P62	51	Operating hours of the relay		P84	55	Simulation mode	
P63	51	Number of switching cycles of the relay		P85	55	Simulation cycle time	
P64	51	Actual temperature of the transducer		P86	55	Simulation low level	
P65	45	Maximum temperature of the transducer		P87	55	Simulation high level	
P66	51	Minimum temperature of the transducer		P88		N.A.	
P67		N.A.		P89		N.A.	
P68		N.A.		P90		N.A.	
P69		N.A.		P91		N.A.	
P70	52	Echo Map		P92		N.A.	
P71	52	Distance of the measuring window		P93		N.A.	
P72	52	Amplitude of the in the measuring window		P94		N.A.	
P73	52	Distance of the in the measuring window		P95		N.A.	
P74	52	Signal / noise ratio		P96		N.A.	
P75	52	Blocking Distance		P97	54	Software code	
P76	53	Waterhead of the flow		P98		N.A.	
P77	53	TOT1 volume flow totaliser		P99	55	Access lock	

9. SOUND VELOCITIES IN DIFFERENT GASES

The following table contains the sound velocity of various gases measured at 20 °C.

Gases		Sound Velocity (m/s)
Acetaldehyde	C_2H_4O	252.8
Acetylene	C_2H_2	340.8
Ammonia	NH_3	429.9
Argon	Ar	319.1
Benzene	C_6H_6	183.4
Carbon dioxide	CO_2	268.3
Carbon monoxide	CO	349.2
Carbon tetrachloride	CCl_4	150.2
Chlorine	Cl_2	212.7
Dimethyl ether	CH_3OCH_3	213.4
Ethane	C_2H_6	327.4
Ethanol	C_2H_5OH	267.3

Gases		Sound Velocity (m/s)
Ethylene	C_2H_4	329.4
Helium	He	994.5
Hydrogen sulphide	H_2S	321.1
Methane	CH_4	445.5
Methanol	CH_3OH	347
Neon	Ne	449.6
Nitrogen	N_2	349.1
Nitrogen monoxide	NO	346
Oxygen	O_2	328.6
Propane N.A.	C_3H_8	246.5
Sulphur hexafluoride	SF_6	137.8

sba480en0902p
April, 2009

NIVELCO reserves the right to change technical data without notice!