

***BINMASTER***<sup>®</sup>

# **3DLevelScanner**



---

## **Different Ways of Connecting to 3DLevelScanner**

---

## **Table of Contents**

Abstract.....	3
1. Connection via 4...20mA. ....	4
2. Connection via Paperless Recorder (based on 4...20mA) ....	5
3. Connection via HART ....	6
4. Connection via 3DLinkPro using GSM cellular communication ....	7
5. Connection via GPRS ....	9
6. Connection via TCP/IP (using COM server) ....	12
7. Connection via Modbus ....	14
8. Connection via RS485 ....	15

## Abstract

This document describes different methods for connecting the 3DLevelScanner (types S/M/MV) to variety of systems.

 Note: All methods of connections are for recommendations only and the user may use more or other solutions to get connected to the 3DLevelScanner.

## 1. Connection via 4...20mA.

- a. The 4...20mA current output is available through ports 3,4 of the left green connector (as shown in the drawing below). Ports 3 and 4 are the negative and positive poles, respectively.

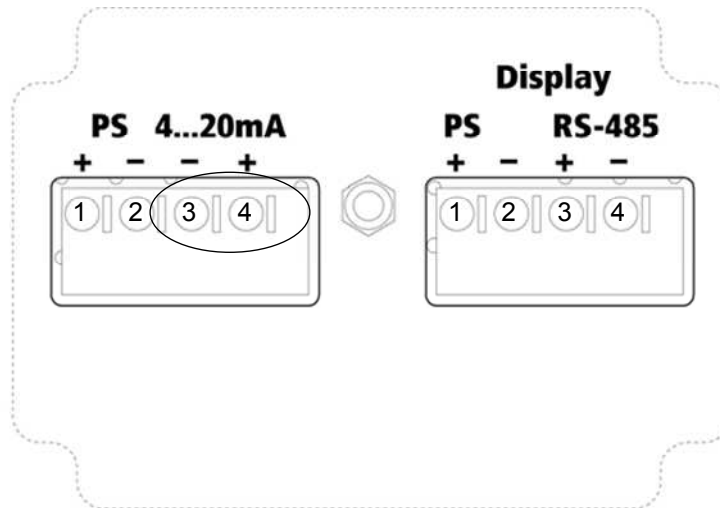

- b. The 4...20mA line goes directly from the scanner mounted on the vessel to the PLC/device (as shown below).

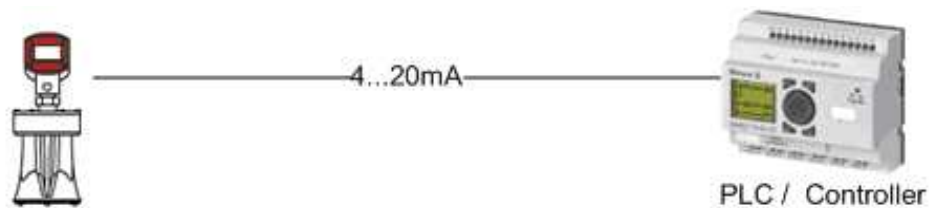

Note:

- This connection does not require the BinMaster 3DLevel Manager Software tool.
- This type of connection is active and not passive, hence the 3DLevelScanner is the active module and the PLC should be the passive module.

## 2. Connection via Paperless Recorder (based on 4...20mA)

- a. Each mounted scanner is connected directly to the recorder via ports 3,4 of the left green connector as shown below. Ports 3 and 4 are the negative and positive poles, respectively.

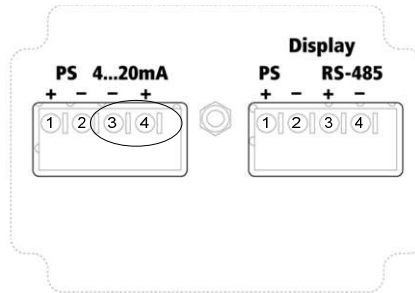

- b. The paperless recorder gathers all the 4...20mA inputs and displays the measurement on its screen (an example of connection of 7 scanners mounted on 7 silos is shown below):

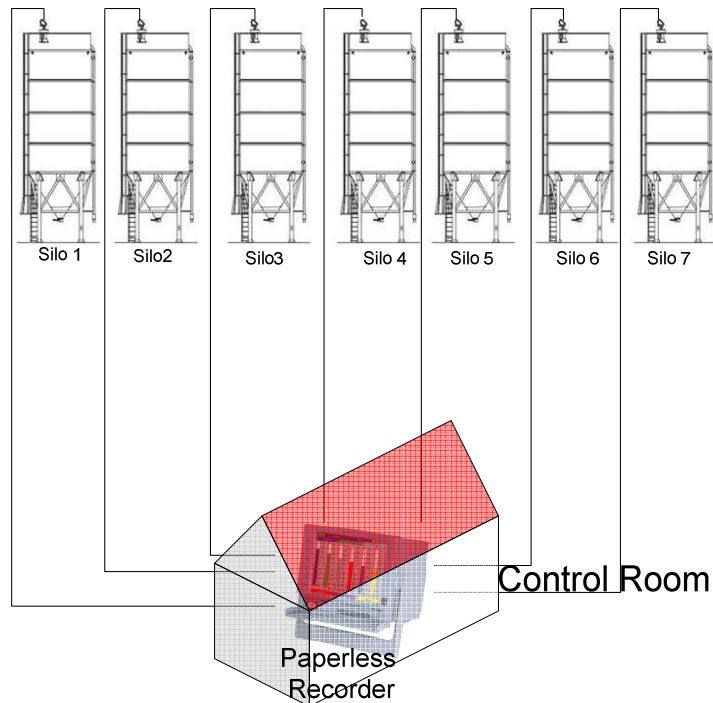

Note:

- This connection does not require the BinMaster 3DLevel Manager Software tool.
- This type of connection is active and not passive, hence the 3DLevelScanner is the active module and the PLC should be the passive module.

### 3. Connection via HART

- a. The HART connection is via ports 3,4 of the left green connector as shown below.

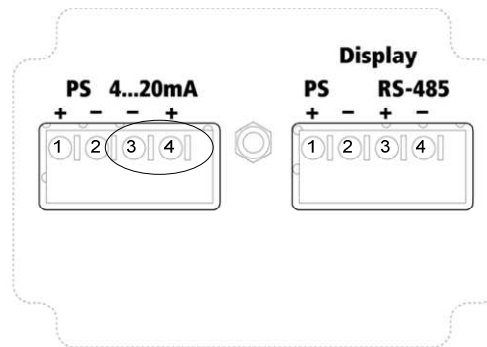

**!** Note:

1. The HART connection has no polarity (it is allowed to switch between ports 3 and 4).
2. The diagram below shows a combined connection of HART and 4...20mA.

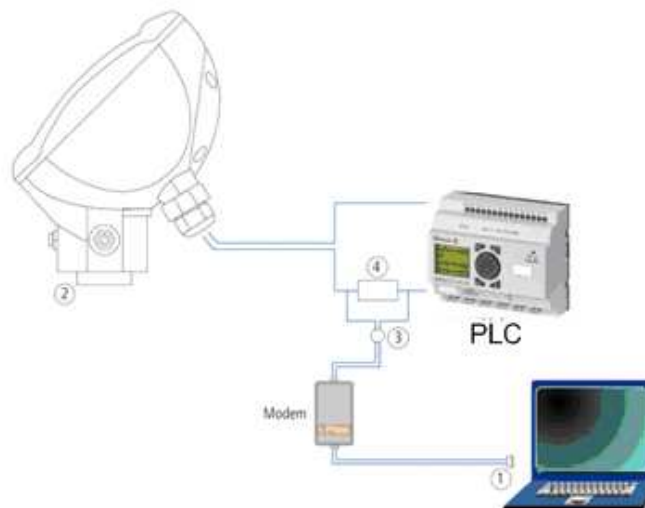

1. RS-232/USB connection
2. 3DLevelScanner
3. HART Adapter cable
4. HART Resistance—250 ohm

#### 4. Connection via 3DLinkPro using GSM cellular communication

- a. In this method a GSM modem is connected to a PC and the 3DLinkPro is connected to the scanner (as shown below):



- b. The connection between the scanner and the 3DLinkPro is via the RS485 ports in the electronic card, using ports 3,4 of the right connector (as shown below):

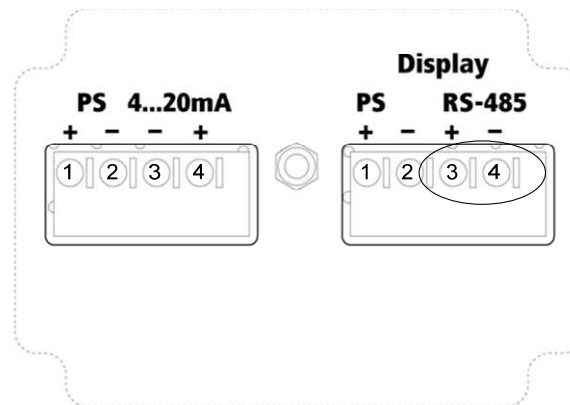

- c. The RS485 layer requires a parallel connection (all '+' connected together and all '-' connected together)

! Note (1): The RS485 allows a multi drop connection of up to 64 scanners (as shown below):

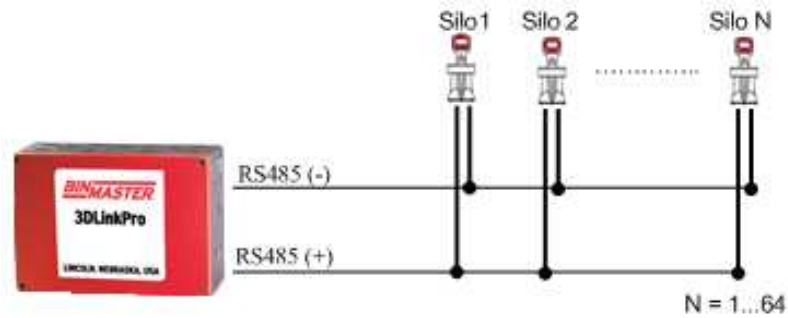

**!** Note (2): There should be a termination resistor of 120ohms between the RS485 lines; hence, placed between the positive (+) and negative (-) lines of the RS485.

- d. Operation of the BinMaster 3DLevel Manager (PC side) in this method
  - i. Run the BinMaster 3DLevel Manager and go to Device → Manually Connect menu.
  - ii. In the connection method form choose the GSM radio button.
  - iii. Set the serial COM port the GSM modem is connected to.
  - iv. Set the polling address of the scanner you wish to get connected to.
  - v. Set the scanner name and the SIM card number (the one in the 3DLinkPro connected to the scanner) in the right pane of the connection frame.
  - vi. Then press the *Connect* button.

The screenshot shows the 'Manually Connect' dialog box. It has a title bar 'Manually Connect' and a subtitle 'Please select your preferred connection method:'. The dialog is divided into several sections:

- Connection Method:** Contains radio buttons for HART, RS485, GSM (Modem) (which is selected), GPRS, GPRS + SMS, and TCP/IP.
- Configuration:** Contains dropdown menus for Serial Port (set to 3), Polling Address (set to 00), and Audit Communication (set to No).
- Further Configuration:** Contains a dropdown for Site name (set to Test Site) and a text field for Phone number (set to 555 430 3503).
- Buttons:** A 'Connect' button is located at the bottom left, and a scrollable area is at the bottom right.



## 5. Connection via GPRS

- a. The physical connection of the scanners and the 3DLinkPro is done exactly the same as in GSM method (see clause 4)
- b. On the PC side, the communication to the scanner will be done via a local internet network.
- c. Pre steps – Local Network Preparations:
  - i. In order to get connected from a local PC in a shared network, it is required to do the following configurations:
    1. Acquire the external IP of the shared network (e.g. browse to [www.whatismyip.com](http://www.whatismyip.com))
    2. Find the IP address of the local PC running the BinMaster 3DLevel Manager
    3. Set a port number which will be used for connection on the local PC.
    4. Configure the network's gateway for port forwarding ("NAT") so that any connection to the port chosen on clause 3 will be forwarded to the IP address of the local machine (from clause 2). It is advised that this task is done by the network administrator.
    5. Contact the cellular provider (the provider of the SIM card in the 3DLinkPro) and get the APN (Access Point Name) word for GPRS connection.
- d. Below is a configuration example. In this example we have:
  1. External IP is 212.235.113.27
  2. There are 3 local machines with IP addresses:
    - a. 192.168.1.104
    - b. 192.168.1.105
    - c. 192.168.1.106
  3. The gateway is configured so that port 7040 is forwarded to IP address 192.168.1.104; port 7050 is forwarded to IP address 192.168.1.105; port 7068 is forwarded to IP address 192.168.1.106.
  4. The APN word of the cellular provider is "internet.t-mobile".
  5. The number of the SIM card in the 3DLinkPro is: +972-54-6488891

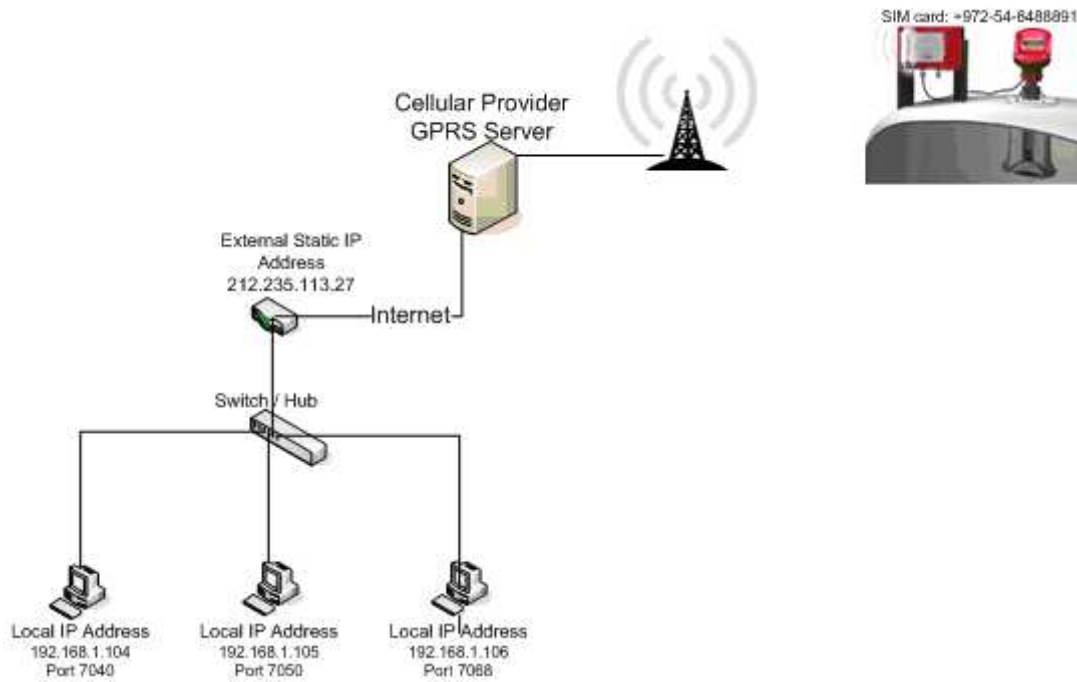

Network Connections Scheme

6. Operation of the BinMaster 3DLevel Manager (PC side) in this example
  - a. Run the BinMaster 3DLevel Manager and go to Device→ Manually Connect menu.
  - b. Select in the Manually Connect window the GPRS radio button (see image below).
  - c. In order to connect to PC with the local IP address 192.168.1.104, set the "Local IP Port" field to 7040.
  - d. Set the polling address of the scanner you wish to get connected to.
  - e. Then press the *Connect* button.

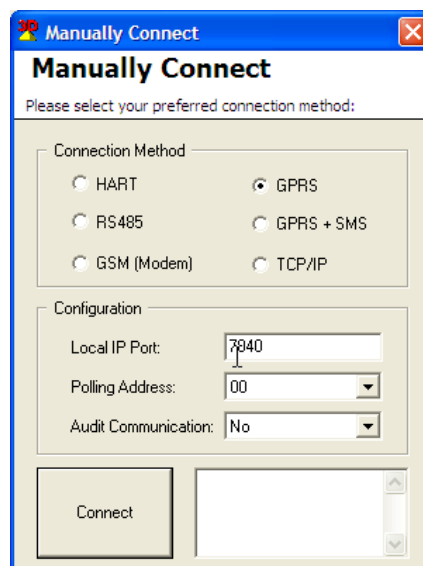

Manually Connect Window

**Comment:** Since this method involves TCP/IP communication, a Windows message might appear (see image below), in that case, select the unlock option.



Window Security Message

f. The 'Wait for Connection' window will pop up:

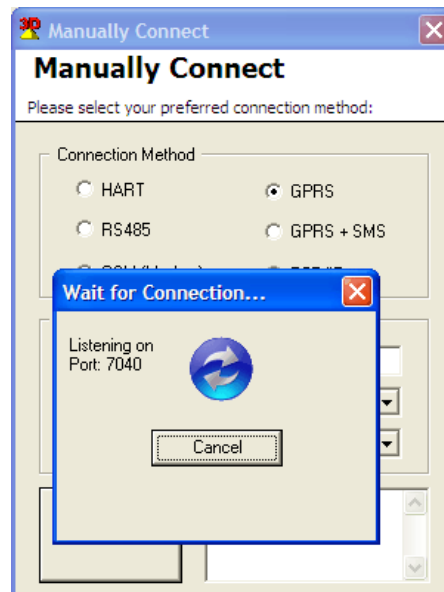

3DLevel Manager ready for connection

g. The local PC is now ready to be connected via GPRS.

h. Send the following SMS message to the number of SIM card in the 3DLinkPro:

*CALLAPM,212.235.27.113,7040,internet.t-mobile,*

! Important: the SMS message should be in the exact same format as above (case sensitive, no spaces and commas).

i. The local PC will get connected within minutes (depending on the networking latency and quality).

! Important Note: There should be a termination resistor of 120ohms between the RS485 lines; hence, placed between the positive (+) and negative (-) lines of the RS485.

## 6. Connection via TCP/IP (using COM server)

- a. The Communication between the scanner and the COM server is via RS485.
- b. The Communication between the COM server and the PC / Laptop is via the TCP/IP networking.
- c. A 120 ohm resistor must be connected in parallel to the RS485 line (as shown below).

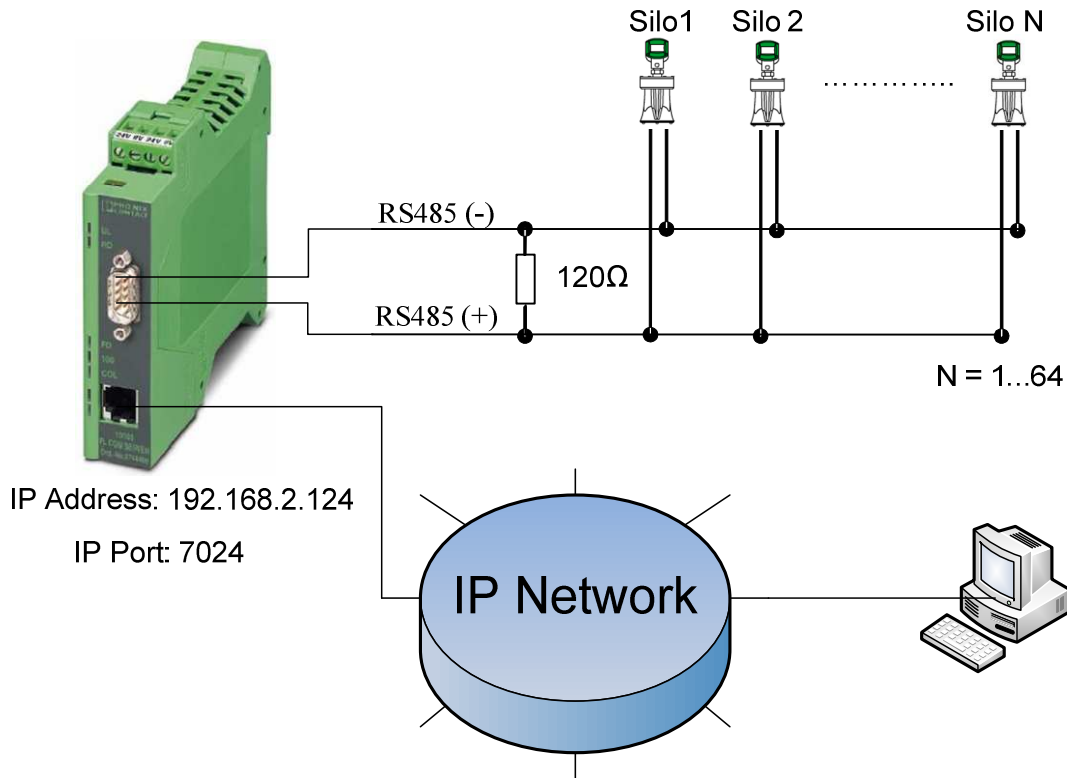

- d. Operation of the BinMaster 3DLevel Manager (PC side)
  - i. Run the BinMaster 3DLevel Manager and go to Device→ Manually Connect menu.
  - ii. Select in the Manually Connect window the TCP/IP radio button (see image below).
  - iii. Set the IP address of the COM server (e.g. 192.168.2.124) in the "Server IP Address" field.
  - iv. Set the IP port of the COM server (e.g. 7024) in the "Server IP Port" field.
  - v. Set the polling address of the scanner you wish to get connected to.
  - vi. Then press the *Connect* button.

**Manually Connect**

Please select your preferred connection method:

**Connection Method**

HART       GPRS

RS485       GPRS + SMS

GSM (Modem)       TCP/IP

**Configuration**

Serial Port: 3

Polling Address: 00

Audit Communication: No

**Further Configuration**

Site name: Test Site

Server IP Address: 192.168.254.254

Server IP Port: 7040

Connect

 **Important Note:** There should be a termination resistor of 120ohms between the RS485 lines; hence, placed between the positive (+) and negative (-) lines of the RS485.

## 7. Connection via Modbus

- a. Initial Settings:
  - i. Comport settings
    1. Baud Rate = 115200
    2. Data Bits = 8
    3. Parity = None
    4. Stop Bits = 1
- b. In order to get the values from the Scanner, a Modbus RTU command with function code 3 should be executed.
- c. The address of the device equals its Polling Address + 1
- d. Registers - The relevant parameters are stored in registers 40001-40016 (see table).

No.	Register Number	Parameter	Units
1	40001 & 40002	Avg. Distance	m
2	40003 & 40004	Min Distance	m
3	40005 & 40006	Max Distance	m
4	40007 & 40008	Volume	%
5	40009 & 40010	4-20mA	mA
6	40011 & 40012	SNR	dB
7	40013 & 40014	Temperature	<sup>0</sup> C
8	40015 & 40016	Temperature	<sup>0</sup> F

- e. All parameters are stored as IEEE754 floating point, and hence, each parameter is stored in two consecutive registers. The byte sending order is from high to low.
- f. Communication examples for a device with polling address 0:
  - i. Example A:
    1. To retrieve the average distance, we send:  
01 03 00 00 00 02 CB 04
    2. A sample reply would be: 01 03 04 3D 85 1E 20 EE 0E.  
This means that Distance = 0x3D851E20, which represents a float value of "0.065".
  - ii. Example B:
    1. to acquire all relevant parameters, we send:  
01 03 00 00 00 10 44 06

## 8. Connection via RS485

a. The physical layer is RS-485 as follows:

1. Baud Rate = 115200
2. Data Bits = 8
3. Parity = None
4. Stop Bits = 1

b. The available parameters and their units are as follows:

Parameter	Units
Avg. Distance	m
Min Distance	m
Max Distance	m
Volume	%
4-20mA	mA
SNR	dB
Temperature	<sup>o</sup> C
Temperature	<sup>o</sup> F

c. To retrieve all eight parameters, the controller needs to transmit a single command. The Packet format of the request is as follows:

1 BYTE            1 BYTE            4 BYTES            2 BYTES

Polling Address +1	03	00 00 00 10	CRC-16
--------------------	----	-------------	--------

- The above values are all in hexadecimal
- For CRC-16, see reference implementation in Appendix B

The below table indicates the request string for each polling address:

Polling Address	Request
00	01 03 00 00 00 10 44 06
01	02 03 00 00 00 10 44 35
02	03 03 00 00 00 10 45 E4
03	04 03 00 00 00 10 44 53
04	05 03 00 00 00 10 45 82
05	06 03 00 00 00 10 45 B1
06	07 03 00 00 00 10 44 60
07	08 03 00 00 00 10 44 9F
08	09 03 00 00 00 10 45 4E
09	0A 03 00 00 00 10 45 7D
10	0B 03 00 00 00 10 44 AC
11	0C 03 00 00 00 10 45 1B
12	0D 03 00 00 00 10 44 CA

13	0E 03 00 00 00 10 44 F9
14	0F 03 00 00 00 10 45 28
15	10 03 00 00 00 10 47 47

d. Then, the packet format of the reply is as follows:

1 BYTE	1 BYTE	1 BYTES	4 BYTES	4 BYTES	4 BYTES	4 BYTES	4 BYTES	4 BYTES	4 BYTES	4 BYTES	2 BYTES
Polling Address +1	03	20	Avg. Distance	Min Distance	Max Distance	Volume	4-20mA	SNR	Temp (C <sup>0</sup> )	Temp (F <sup>0</sup> )	CRC-16

- Each of the eight 4-bytes-block represents a floating point value according to the IEEE-754 standard. We refer the reader to: [http://en.wikipedia.org/wiki/IEEE\\_754-1985](http://en.wikipedia.org/wiki/IEEE_754-1985)
- Example:

i. Suppose the reply starts as follows:

Byte Number	Value
00	01
01	03
02	20
03	3D
04	85
05	1E
06	20

- ii. Then the average distance is represented by a 4-bytes-block of 0x3D851E20 which corresponds to floating point value of 0.065m.

To verify, enter "3d851e20" in the *hexadecimal representation* text box at the following webpage:

<http://babbage.cs.qc.cuny.edu/IEEE-754/32bit.html>



## **Appendix A – Example using InTouch System**

1. This example uses TOP Server with version:



2. Create a new file.
3. Create a new channel with the following definitions:

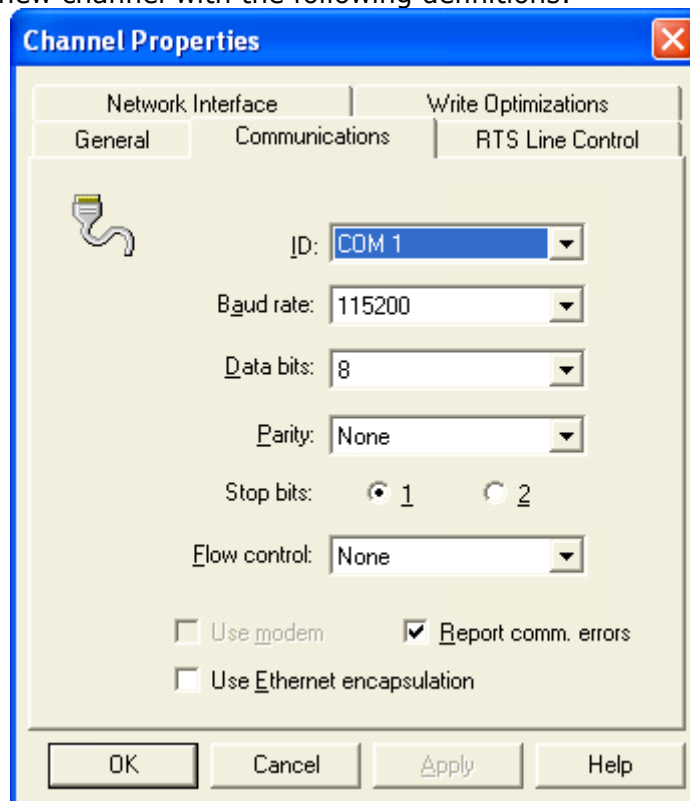

3. Add a new device (MODBUS serial) and set the following properties:

3.1 ID = polling address +1

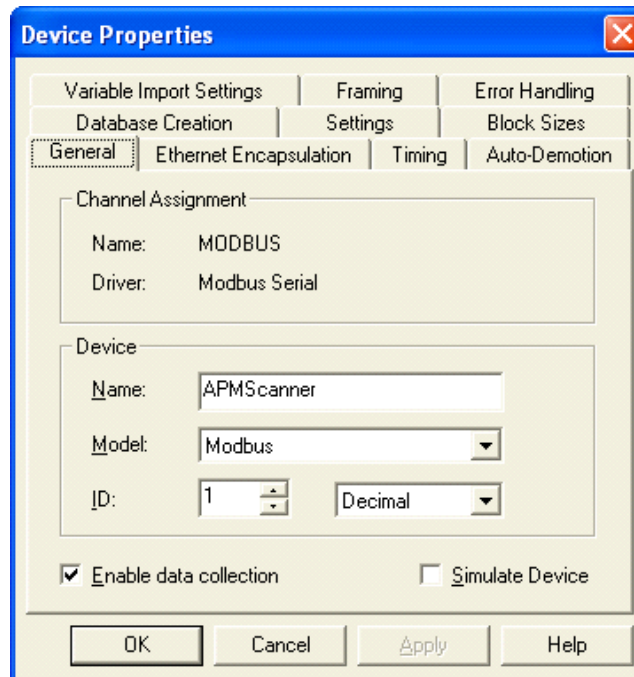

3.2

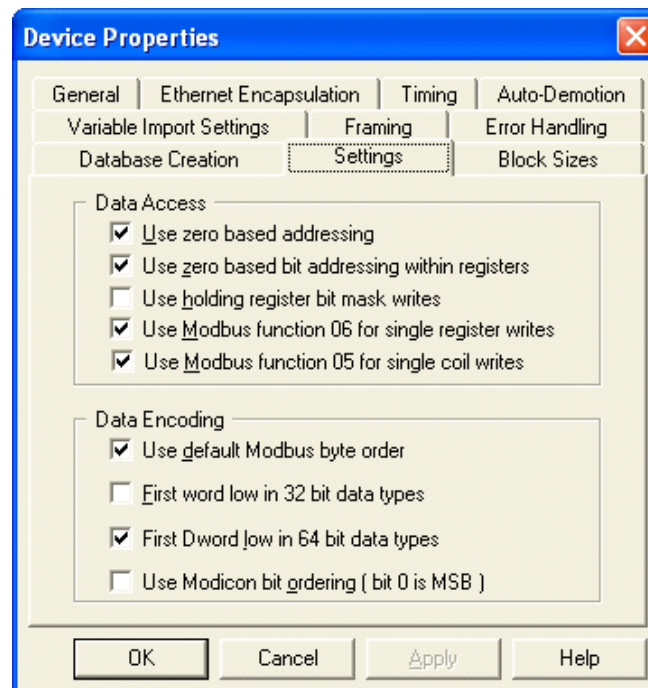

4. Create tag Properties according to the table in page 2 / clause 4

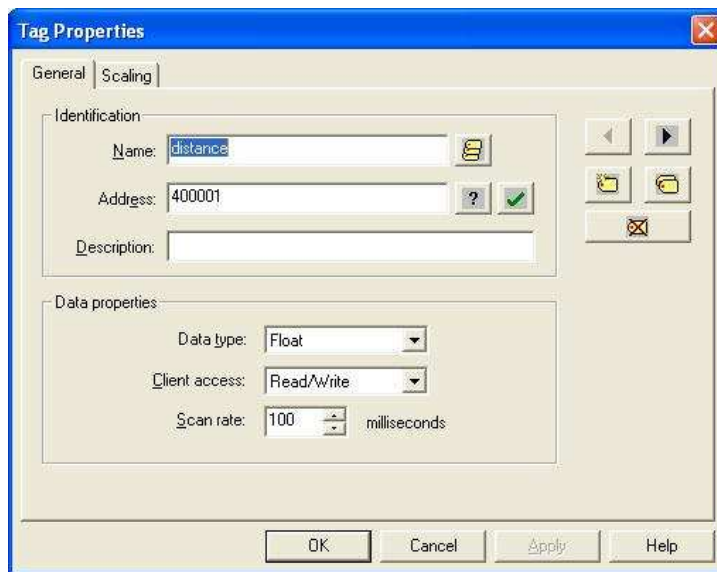

5. The TOP Server will then present all the registers as follows:

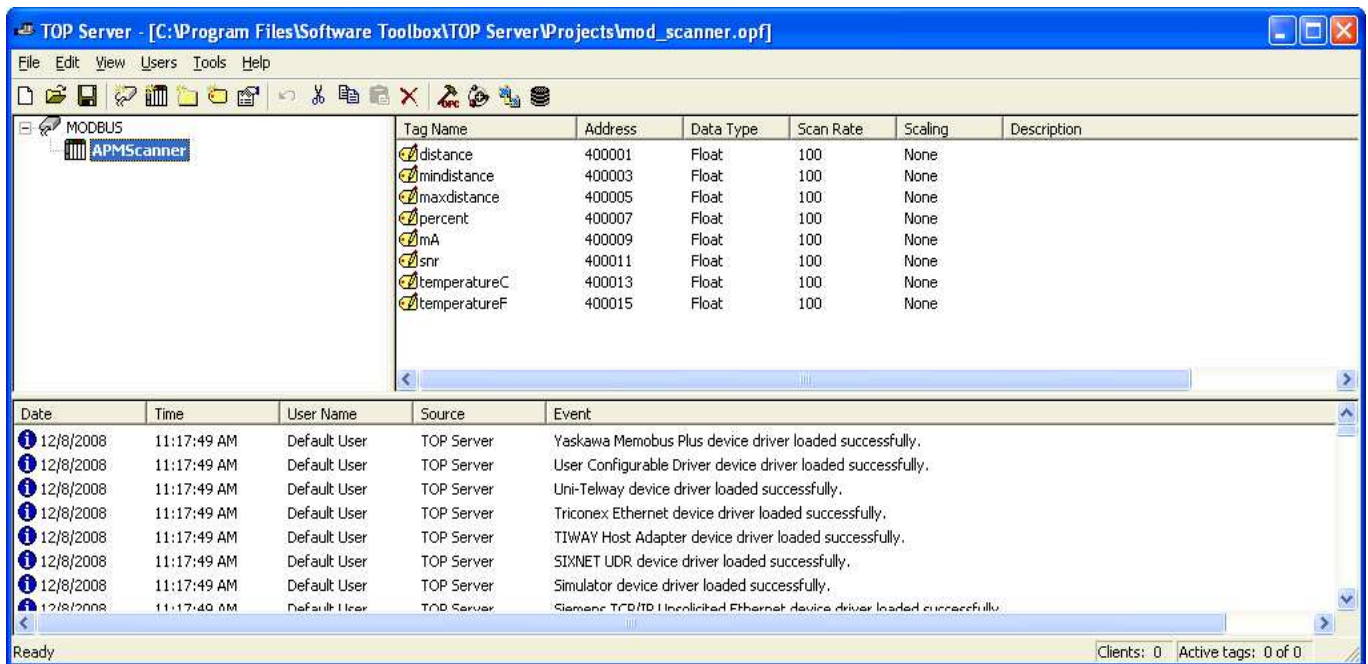

**In the InTouch configure the following:**

1. Create a new access name with topic name = alias name from TOP Server:

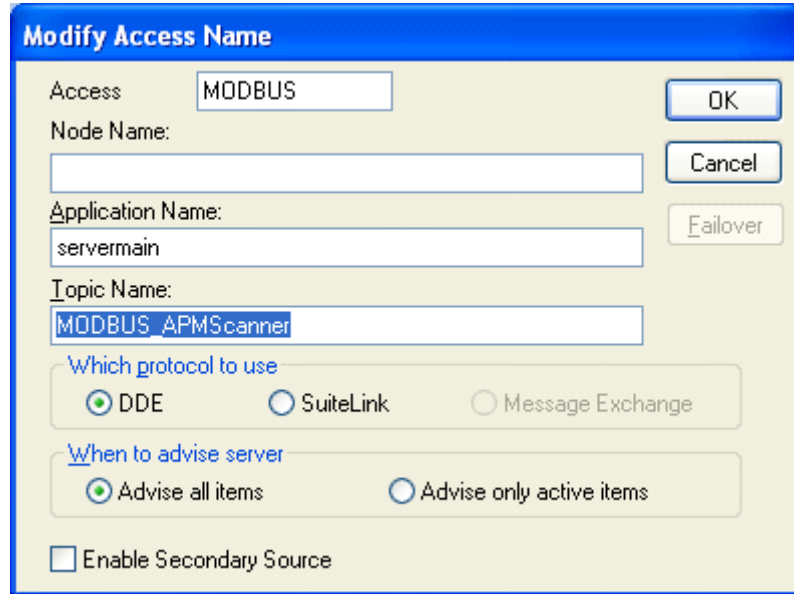

2. Topic name should be the same as the alias name in TOP Server (in this example connecting to *BinMasterScanner* device in MODBUS channel, this means the access name should be *MODBUS\_APMScanner*) see image below:

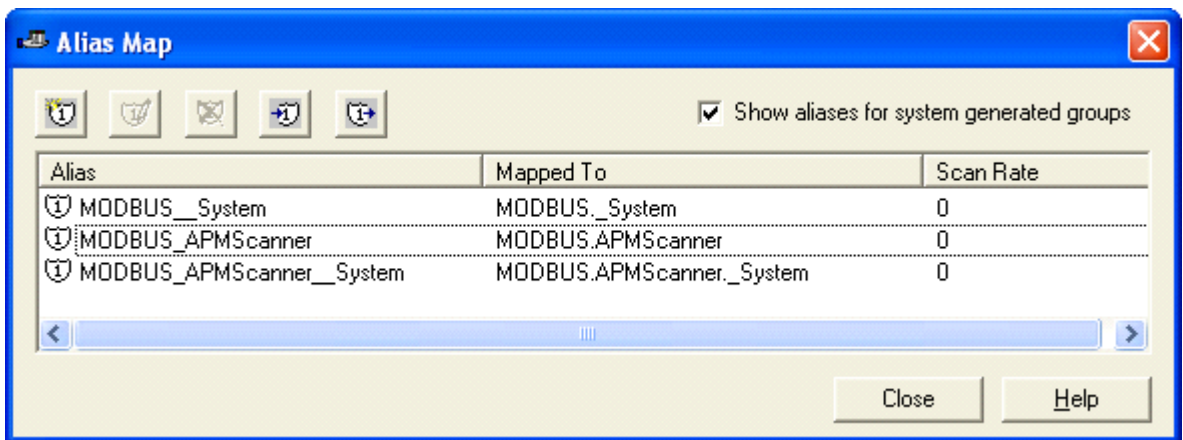

- Define tags according to your tag names definitions in TOP Server. Put your created access name

- Create a new screen with some texts that will display analog value:

5. In the expression put the tag name:

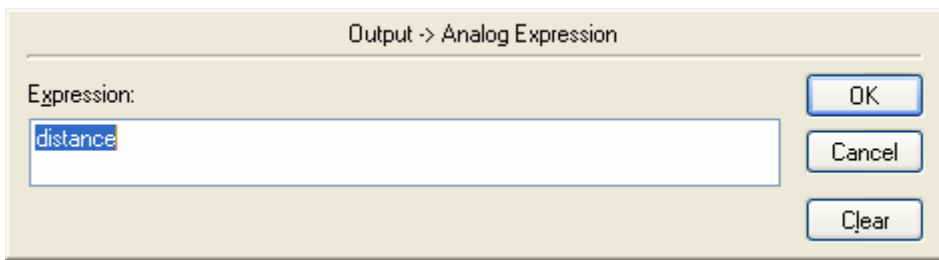

6. The windowViewer of InTouch will then present the outcome:

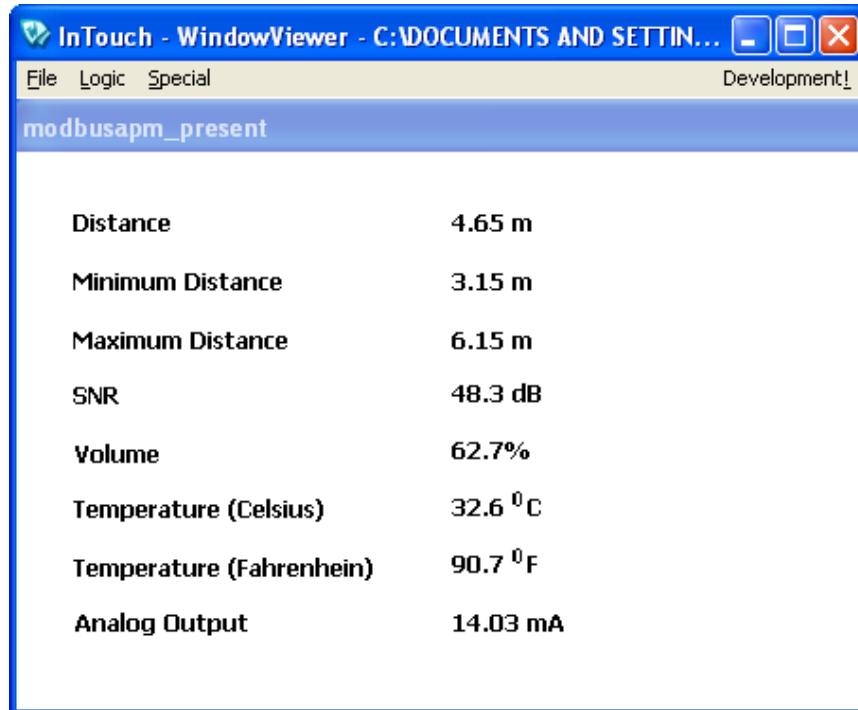

## **Appendix B – CRC-16 Reference implementation**

```
//
// code for computing crc-16
//
// The polynomial is
// X^16+X^15+X^2+X^0

/* Table of CRC values for high-order byte */
unsigned char crc16tableHI[256] = {
0x00,0xC1,0x81,0x40,0x01,0xC0,0x80,0x41,0x01,0xC0,0x80,0x41,0x00,0xC1,0x81,
0x40,0x01,0xC0,0x80,0x41,0x00,0xC1,0x81,0x40,0x00,0xC1,0x81,0x40,0x01,0xC0,
0x80,0x41,0x01,0xC0,0x80,0x41,0x00,0xC1,0x81,0x40,0x00,0xC1,0x81,0x40,0x01,
0xC0,0x80,0x41,0x00,0xC1,0x81,0x40,0x01,0xC0,0x80,0x41,0x01,0xC0,0x80,0x41,
0x00,0xC1,0x81,0x40,0x01,0xC0,0x80,0x41,0x00,0xC1,0x81,0x40,0x00,0xC1,0x81,
0x40,0x01,0xC0,0x80,0x41,0x00,0xC1,0x81,0x40,0x01,0xC0,0x80,0x41,0x01,0xC0,
0x80,0x41,0x00,0xC1,0x81,0x40,0x00,0xC1,0x81,0x40,0x01,0xC0,0x80,0x41,0x01,
0xC0,0x80,0x41,0x00,0xC1,0x81,0x40,0x01,0xC0,0x80,0x41,0x00,0xC1,0x81,0x40,
0x00,0xC1,0x81,0x40,0x01,0xC0,0x80,0x41,0x01,0xC0,0x80,0x41,0x00,0xC1,0x81,
0x40,0x01,0xC0,0x80,0x41,0x00,0xC1,0x81,0x40,0x00,0xC1,0x81,0x40,0x01,
0xC0,0x80,0x41,0x01,0xC0,0x80,0x41,0x00,0xC1,0x81,0x40,0x01,0xC0,0x80,0x41,
0x00,0xC1,0x81,0x40,0x00,0xC1,0x81,0x40,0x01,0xC0,0x80,0x41,0x00,0xC1,0x81,
0x40,0x01,0xC0,0x80,0x41,0x01,0xC0,0x80,0x41,0x00,0xC1,0x81,0x40,0x01,0xC0,
0x80,0x41,0x00,0xC1,0x81,0x40,0x01,0xC0,0x80,0x41,0x01,0xC0,0x80,0x41,0x01,
0xC0,0x80,0x41,0x00,0xC1,0x81,0x40,0x01,0xC0,0x80,0x41,0x01,0xC0,0x80,0x41,
0x00,0xC1,0x81,0x40,0x01,0xC0,0x80,0x41,0x01,0xC0,0x80,0x41,0x00,0xC1,0x81,
0x40
} ;

/* Table of CRC values for low-order byte */
unsigned char crc16tableLO[256] = {
0x00,0xC0,0xC1,0x01,0xC3,0x03,0x02,0xC2,0xC6,0x06,0x07,0xC7,0x05,0xC5,0xC4,
0x04,0xCC,0x0C,0x0D,0xCD,0x0F,0xCF,0xCE,0x0E,0x0A,0xCA,0xCB,0x0B,0xC9,0x09,
0x08,0xC8,0xD8,0x18,0x19,0xD9,0x1B,0xDB,0xDA,0x1A,0x1E,0xDE,0xDF,0x1F,0xDD,
0x1D,0x1C,0xDC,0x14,0xD4,0xD5,0x15,0xD7,0x17,0x16,0xD6,0xD2,0x12,0x13,0xD3,
0x11,0xD1,0xD0,0x10,0xF0,0x30,0x31,0xF1,0x33,0xF3,0xF2,0x32,0x36,0xF6,0xF7,
0x37,0xF5,0x35,0x34,0xF4,0x3C,0xFC,0xFD,0x3D,0xFF,0x3F,0x3E,0xFE,0xFA,0x3A,
0x3B,0xFB,0x39,0xF9,0xF8,0x38,0x28,0xE8,0xE9,0x29,0xEB,0x2B,0x2A,0xEA,0xEE,
0x2E,0x2F,0xEF,0x2D,0xED,0xEC,0x2C,0xE4,0x24,0x25,0xE5,0x27,0xE7,0xE6,0x26,
0x22,0xE2,0xE3,0x23,0xE1,0x21,0x20,0xE0,0xA0,0x60,0x61,0xA1,0x63,0xA3,0xA2,
0x62,0x66,0xA6,0xA7,0x67,0xA5,0x65,0x64,0xA4,0x6C,0xAC,0xAD,0x6D,0xAF,0x6F,
0x6E,0xAE,0xAA,0x6A,0x6B,0xAB,0x69,0xA9,0xA8,0x68,0x78,0xB8,0xB9,0x79,0xBB,
```

```

0x7B,0x7A,0xBA,0xBE,0x7E,0x7F,0xBF,0x7D,0xBD,0xBC,0x7C,0xB4,0x74,0x75,0xB5,
0x77,0xB7,0xB6,0x76,0x72,0xB2,0xB3,0x73,0xB1,0x71,0x70,0xB0,0x50,0x90,0x91,
0x51,0x93,0x53,0x52,0x92,0x96,0x56,0x57,0x97,0x55,0x95,0x94,0x54,0x9C,0x5C,
0x5D,0x9D,0x5F,0x9F,0x9E,0x5E,0x5A,0x9A,0x9B,0x5B,0x99,0x59,0x58,0x98,0x88,
0x48,0x49,0x89,0x4B,0x8B,0x8A,0x4A,0x4E,0x8E,0x8F,0x4F,0x8D,0x4D,0x4C,0x8C,
0x44,0x84,0x85,0x45,0x87,0x47,0x46,0x86,0x82,0x42,0x43,0x83,0x41,0x81,0x80,
0x40
};

```

```

unsigned short DoCrc16Block( unsigned char *s, unsigned short length )
{
    unsigned char HI = 0xFF ; /* high byte of CRC initialized */
    unsigned char LO = 0xFF ; /* low byte of CRC initialized */
    unsigned i ;             /* index into CRC lookup table */

    while (length--)
    {
        i = LO ^ *s++;
        LO = crc16tableHI[i] ^ HI;
        HI = crc16tableLO[i];
    }
    return (HI << 8 | LO) ;
}

```





